



VAUTH-
SAGEL
**STORAGE
SOLUTIONS**
24/25





◀ HEINRICH SAGEL (LEFT) AND
HERMANN VAUTH (RIGHT)

Everything starts with an idea. An idea that we believe in, that drives us every day and that surprises and excites us again and again.

” *We want to create high-quality system solutions for living spaces. For everyone, everywhere in the world!*

This is the idea that Hermann Vauth and Heinrich Sagel conceived in 1962. And that we still hold on to today. Every day. To us, space is in the eye of the beholder. We see solutions where others look away. We never rest on our laurels. We are always thinking one step ahead and looking for new challenges in order to recognize and redefine the living spaces of tomorrow and to facilitate and beautify everyday life.

MAXIMUM FUNCTIONALITY AND HIGH-QUALITY DESIGN FOR EVERY KITCHEN AND UTILITY ROOM.



VS TAL®
TALL CABINETS

VS ENVI®
WASTE BIN
SYSTEMS

+ **VS ADD®**
ACCESSORIES

VS TOP®
WALL CABINETS

VS COR®
CORNER CABINETS



NEW
LIGANO DESIGN
NEW
ACCESSORIES
& VS WASH®

CONTENTS

ABOUT VAUTH-SAGEL 06

Quality	06
Design	08
Sustainability	10
Facts and Figures	12
Our Service	14
Packaging	16
Useful Information	18
Naming	20
DESIGN VARIATIONS	22

VS ENVI® – WASTE BIN SYSTEMS 24

VS ENVI® Space XX	26
VS ENVI® Kick	31
VS ENVI® BMT Saphir	32
VS ENVI® BMT Planero	38
VS ENVI® BMT Ligano	42

VS COR® – CORNER CABINETS 46

VS COR® – BLIND CORNER	
VS CORNERSTONE® MAXX	48
VS CORNERSTONE® Swing	52
VS COR® Flex	56
VS COR® – LAZY SUSAN	
VS COR® Wheel Pro	60
VS COR® Susan Kidney / Fullround	64
VS COR® Susan Kidney / Fullround / Ligano	70
VS COR® Susan Pie Cut	72

VS SUB® – BASE CABINETS 74

VS SUB® Side	76
VS SUB® Pantry	80
VS Pantry Flex	84
VS SUB® Rack Ligano	86

VS TAL® – TALL CABINETS 90

VS TAL® Pantry	92
VS Pantry Flex	100

VS TOP® – WALL CABINETS 102

VS TOP® Hang 26	104
VS TOP® Hang 40	106

VS ADD® – ACCESSORIES 108

VS ADD® Board	110
VS ADD® Box	112
VS ADD® Separator	116
VS ADD® Iron	118

VS WASH® 120

VS WASH® Space XX / Pro	122
-------------------------	-----

VS SUB®
BASE CABINETS

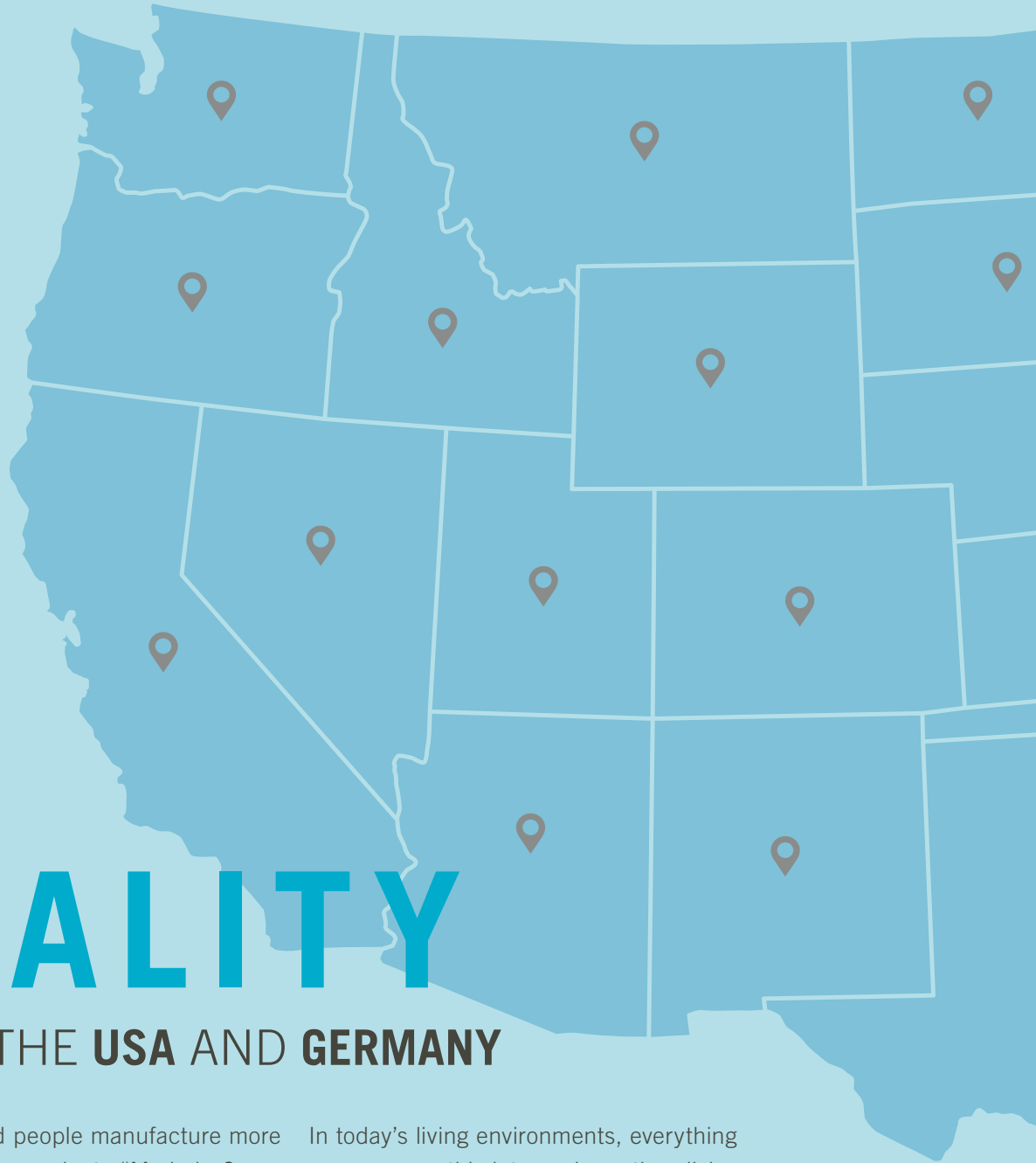

QUALITY

MADE IN THE **USA** AND **GERMANY**

When 1,000 qualified people manufacture more than 85 million quality products “Made in Germany” every year – that’s Vauth-Sagel. Customers around the globe appreciate the innovative strength and quality. Because the individual solutions or modular system solutions make people’s everyday lives easier in all around.

In today’s living environments, everything merges smoothly into each another: living room, dining area, bedroom and bathroom. With our innovative product portfolio, we manage this balancing act, which constantly inspires us to come up with new ideas. We manufacture in Germany and the USA – where else!



QUALITY
MADE IN
USA

X



VAUTH
SAGEL
QUALITY
MADE IN GERMANY





*VS CORNERSTONE® Maxx
IS AN IMPRESSIVE AMBASSADOR OF
GERMAN DESIGN COMBINED WITH
HIGH ENGINEERING SKILLS.*

WHAT MAKES US EXCELLENT:

EXCELLENT DESIGN.

We focus on combining design and functionality. Our stylish pull-out systems are not only beautiful to look at; they also offer high-quality convenience and help to make everyday life in the kitchen easier. This has been honoured numerous times and we are proud to have received several renowned design awards with our products.



SUSTAINABILITY

WE DON'T JUST TALK ABOUT IT.
WE PUT IT INTO PRACTICE.

Responsibility for people and the environment is firmly anchored at the core of our business and is inextricably linked to the corporate success of our company. That is why we have invested considerably in the consistent implementation of resource-saving measures. We are proud of results, which prove that it is possible to move mountains: 50% energy savings through conversion to LED

lighting, 44% through optimization of the compressed air system and a 35% saving in resources through powder coating are examples of the path that Vauth-Sagel is taking: in the direction of efficient, sustainable recycling management and, as a consequence, a healthy environment with clean water, fertile soils and clean air.

Read our full environmental report here:



EXEMPLARY MEASURES IN OUR PLANTS



Sustainable heating



Identification of compressed air energy saving potentials



Reduction of electricity consumption



Sustainable painting



Power generation through photovoltaics



Optimization of building management and control technology



Sustainable fleet management



Supporting the "Plant for the planet" initiative





VAUTH-SAGEL MISSION

We want people to rediscover highly **comfortable** living environments and therefore create space. **For everyone**, everywhere in the world!

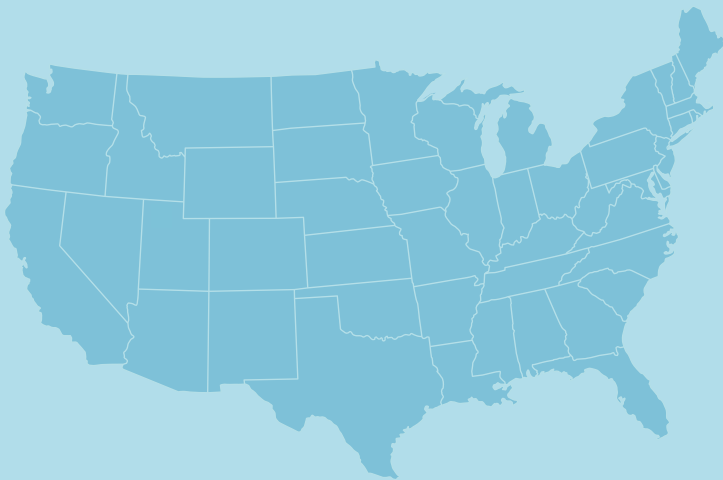

~21,500

SQUARE FEET OF WAREHOUSE SPACE IN THE USA WITH 1,000 AVAILABLE PALLET SPACES

A FAMILY COMPANY, RUN IN THE 2ND GENERATION BY THE

5

SONS OF FOUNDER HEINRICH SAGEL

FOUNDED IN

1962

BY HERMANN VAUTH AND HEINRICH SAGEL



1,000

QUALIFIED EMPLOYEES



PORTFOLIO
WITH OVER
3,500
PRODUCTS

85M

PRODUCTS MANUFACTURED
EVERY YEAR



970,000



SQUARE FEET OF
MANUFACTURING
SPACE IN THE 4
PRODUCTION SITES
IN THE HEART OF
GERMANY

OUR SERVICE

FOR A COMFORTABLE VAUTH-SAGEL EXPERIENCE

For us, comfort is not only a priority when it comes to using our products. We want to create a holistic comfortable Vauth-Sagel experience. That's why we provide you with numerous tools that give inspiration and support you in the planning, selection, installation and maintenance of our products.



INSPIRATION



EXPLAINING



PLANNING

SOCIAL MEDIA

Let us inspire you. Follow us on our social media channels and subscribe to our newsletter to be always up to date and not miss any news.



PRODUCT VIDEOS

Image videos



Product installation videos



SHOP-IN-SHOP DISPLAYS

A modular, compact eye-catcher showing our products in a self-explanatory way.

BENEFIT SHEETS

Highlighting the end consumer and installer benefits at a glance.

SAMPLES

In order to make our products tangible, we provide our partners with product samples.

DIGITAL CATALOG

In the product section on our website you can get an overview of the products we offer. The various filters will take you to the product of your choice. The stored photos, films and product descriptions provide you with important information so that you can convince yourself of the advantages of the respective product.

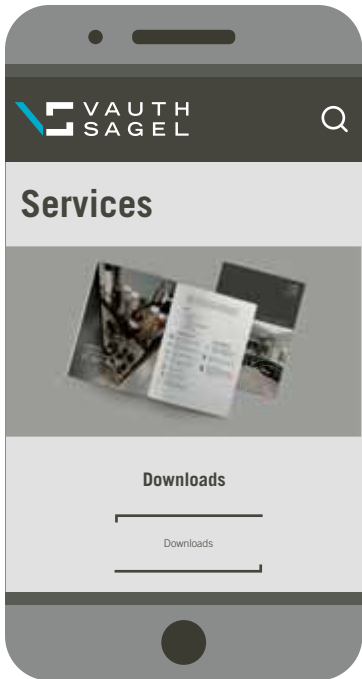

WEBSITE
On our website you will find all tools in a bundled form.

Website link: vauth-sagel.de/us/en/digital-services



TRAINING

VS WEBINARS
Receive qualified product and installation trainings via our online webinars.



MOUNTING

MOUNTING TEMPLATES
To assist you in determining the drilling points, we have developed mounting templates for a large number of our products to make installation easier for you. They are included in the box.

DRILLING DATA
You can find the drilling data for your CNC machine on our website in the product section.

INSTALLATION VIDEOS
Use our installation videos for easy installation of our products. You will find the videos (if available) on our website, our YouTube channel or as QR code on the installation instructions.

ASSEMBLY INSTRUCTIONS
On our assembly instructions you will find the installation of our products explained step by step. They are included in the box and available for download in the product section on our website.



AFTER SALES

SPARE PARTS LISTS
Even the most durable product is not spared wear and tear. Should you ever need a spare part, our spare parts lists will help you. You can find them on our website in the product section.

TECHNICAL SUPPORT
Scan to view and download assembly instructions, drilling data and spare parts lists.



SUSTAINABLE. PROTECTIVE. CONVENIENT.

Our brand promise to offer you the best quality and greatest practicality starts with our packaging. Like we do with our products, which are easy to use and intended to make everyday life easier, we will be placing even more emphasis on providing you maximum convenience

with our packaging in the future. We are therefore consistently committing to your satisfaction in this area as well and have started to optimize our packaging solutions step by step.



Individual parts cannot slip and be damaged during transport



Maximum protection due to high-quality cardboard



Drop tests check whether our packaging can withstand high loads



Branding and graphics provide clarity, order and a high-quality appearance

GREATER EFFICIENCY WHILE USING LESS MATERIAL

Starting with product development through production to packaging, we continually keep an eye on the interests of both people and the environment, even when it comes to everything else that goes on during transport. We have made our packaging more effective and sustainable by:

- Reducing the amount of plastic fill material in favor of cardboard inserts
- Making optimal use of the available space
- Using recyclable materials



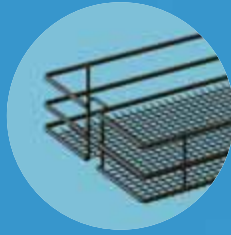

Product



Assembly instructions

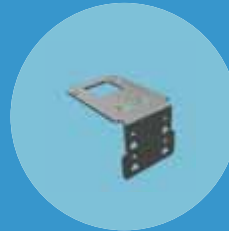

Hardware (if provided)

COMPONENTS

Most of the VS products come in two boxes – one including the frame and runners, the second one including the trays. Some are also shipped in just one box or come with three boxes. On the product pages you can see how many boxes you will receive. The VS boxed products standard packaging is:



Label



Drilling template (if provided)



USEFUL INFORMATION

DIMENSIONS

1



INNER DIMENSIONS

To determine the correct depth of the cabinets, it is not enough to measure only the side outside. Therefore, always measure the cabinet from the inside as well.

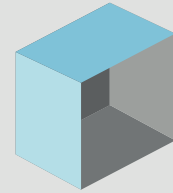

EXTERNAL DIMENSIONS

In addition, specify the external dimensions of the cabinet. These dimensions usually correspond to the cabinet module in inch.

STYLE

2



FRAMELESS / FULL ACCESS

Frameless cabinets provide a modern look and are most commonly seen in European modular-style kitchens. Since the face frame of the cabinet is left out, these cabinets offer full access to the cabinet interior, and larger drawer box capacity.

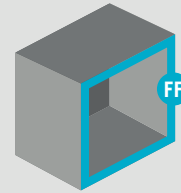

FACE FRAME

A frame is fixed to the front of the cabinet. This is seen in traditional cabinetry. We assume a 1 1/2" face frame.

BLIND CORNERS

3



LEFT DOOR / BLIND RIGHT

If the blind space is to the right, then the door opens to the left. Then the correct shelves are left shelves.



RIGHT DOOR / BLIND LEFT

If the blind space is to the left, then the door opens to the right. Then the correct shelves are right shelves.

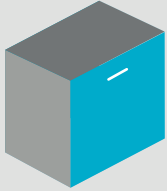

FULL-HEIGHT CABINETS

The product uses the full height of the cabinet.

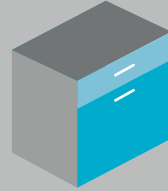

DRAWER/DOOR CABINETS

The product leaves enough space for a drawer above.



APPLICATION

SHORTCUTS

CAB	Cabinet widths	The cabinet width refers to the size of the cabinet the product is designed for.
MCO	Minimum Cabinet opening	The pure opening size of the cabinet through which the product should fit.
D	Installation depth	The minimum depth you need to ensure the product fits perfectly.
H	Installation height	The minimum internal height you need to ensure that the product fits perfectly.
W	Basket or Cabinet Width	The pure width of the basket or cabinet.

CLEAR NAMING IS KEY

With over 3,500 products in our portfolio, we place particular emphasis on clarity. Therefore, we have introduced a stringent nomenclature to make the naming of our products internationally understandable. Our product names are consistently derived from English and consist of three parts: the Vauth-Sagel initials, a product family assignment and a functional attribute.

VS COR[®] Wheel (Pro)



VAUTH-SAGEL INITIALS

By means of this naming, you can see at first glance whether it is a storage solution for a tall cabinet, base cabinet, corner cabinet or a waste bin system. Here, the initials as well as the attribution are completely written in capital letters.

PRODUCT FAMILY ASSIGNMENT

®-SIGN

The registered trademark underlines our claim to quality and that it is a branded product. The registered sign only applies to our product family assignment in combination with our VS initials.

FUNCTIONAL ATTRIBUTE

This part of the name describes a functional attribute of the product: in this case, "Wheel" stands for "round/rotatable". Here, only the initial letter is written in capital letters, the rest in lower case.

ADDITIONAL ADVANTAGE

As a further level of distinction, some names have a single letter or the addition of "Pro" after the attribute – this identifies product variations with an additional advantage.

PRODUCT BENEFITS

Of course, each of our products has specific advantages on both the consumer and installer side. However, some advantages are general and do not refer only to individual products. These are the following:



Save Time

With our products you no longer have to crawl into your cabinets. Even the items in the back can be easily reached. That makes your daily life easier and saves time.

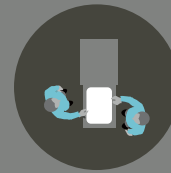

Optimal Access

No need to constantly move around items to find the one you need. Everything is stored in an easy access format.



Retrofit Ready

All our products can be installed in existing cabinetry without removing the countertop. This provides huge remodeling opportunities.

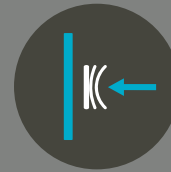

Integrated Soft And Self-Closing

All our products come with a damping mechanism that provides a soft-close action of the unit. For some products the damping mechanism is optional.

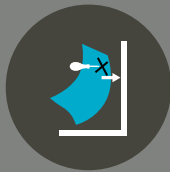

Installation Template

Most of our products come with an installation template for easy installation.

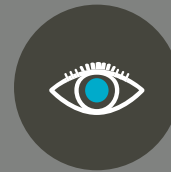

Complete Visibility With One Pull

For most of our products, when the door is opened, every item is instantly visible.

DESIGN VARIATIONS

VERSATILE A
ter of taste when choosing
designed as a modular sys
storage designs.

SAPHIR

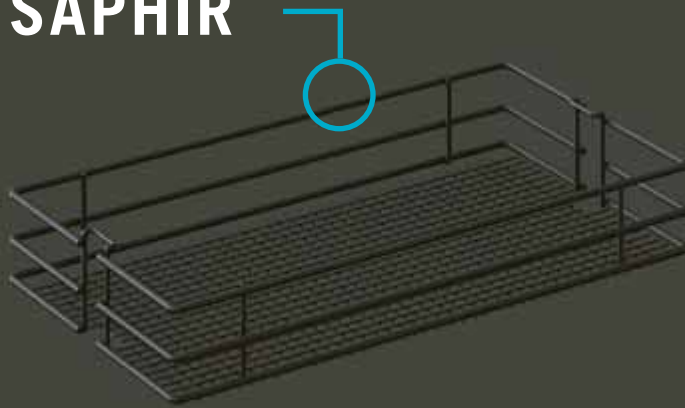

A GEM IN TERMS OF AESTHETICS AND FUNCTIONALITY

This fine mesh wire basket shelf offers a unique look and a stability that can easily cope with any kind of load.

SCALEA

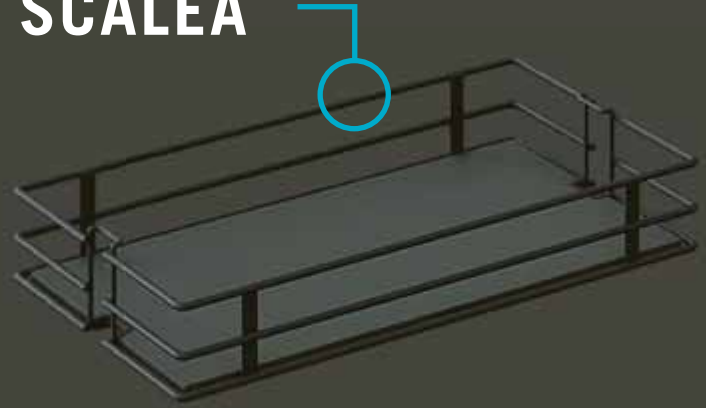

TIMELESS DESIGN FOR AMERICAN KITCHENS

This timeless shelf version upgrades any cabinet interior with a solid wood shelf with an elegant wire guard rail. The wooden shelf offers an optimum base for safely storing everything that's in daily use.



Fine mesh wire basket shelf



Exclusive construction method for excellent stability



Ensures air circulation and transparency



Timeless design



High-quality, elegant wire guard rail



Solid wooden shelf for reliable stability

COLORS



platinum



lava

COLOR COMBINATIONS



lava / lava



lava / walnut



platinum / maple



lava / maple

AND FLEXIBLE Shape and material are often a matter of design. For this reason, the entire Vauth-Sagel program is a system in which the guide and the frame can be combined with all

PLANERO®

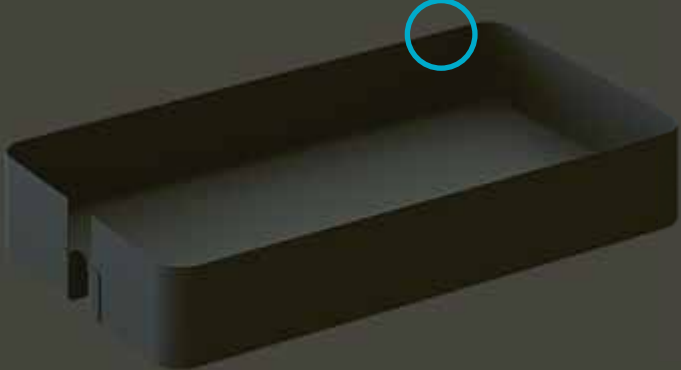

STORAGE DESIGN FOR THOSE WHO LOVE AESTHETICS

Planero ensures that high-quality kitchen design continues seamlessly inside and that the interior and the exterior merge into a consistent whole. The high-quality storage product line with a soft, rounded design makes it possible for you to express your individuality.



Closed storage shelf with elegant sheet-metal edge



Sealing strip all the way round the wooden shelf



Concealed basket brackets

COLOR COMBINATIONS



lava / lava



lava / walnut

NEW

LIGANO



WOOD AT THE HEART OF AMERICAN KITCHENS

Traditional cuisines continue to be just as popular as ever. The Ligano design line ensures a consistent look from the outside in, with elegant storage solutions based on warm woods such as maple and birch complementing the classic style of the kitchen fronts perfectly. Subtle metallic highlights add a contemporary twist.

COLOR COMBINATIONS



platinum / wood



lava / wood



VS ENVI® – WASTE BIN SYSTEMS

Hygiene, environmental awareness and sustainability play a special role in the kitchen – especially in waste disposal. This requires system solutions which

maintain both the cleanliness of the kitchen and a flexible separation. As a result, it's not only your own living space that stays clean, but nature as well.



A BIG HELP IN A
SMALL CABINET.

FOR
FACE FRAME &
FRAMELESS
KITCHEN



VS ENVI® Space XX Pro
Full height version



Watch it!

VS ENVI® Space XX

TOP MOUNTED WASTE BIN

FEATURES



Powder-coated lid
for extra storage

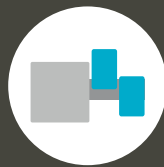

Synchronised runners with
over extension



Easy to clean & dishwasher proof
bins up to 158°F



Bins are made out of
a non-toxic polymer





Convenient carrying handles

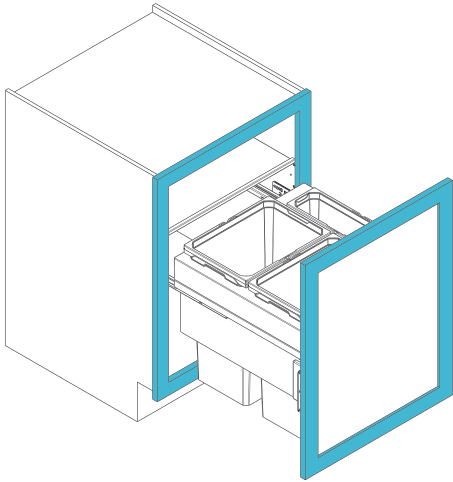

Cam shaft 3-D adjustment

DETAILS



- **Cabinet widths (CAB):** 15", 18", 21" and 24"
 - **Cabinet opening (MCO):**
 - FF 12", 15", 18" and 21"
 - FL 13-1/2", 16-1/2", 19-1/2" and 22-1/2"
 - **FF width:** 1-1/2"
 - **Installation depth:** min. 20-1/2"
 - **Installation height:**
 - VS ENVI® Space XX: min. 19-1/2"
 - VS ENVI® Space XX Pro: min. 23"
 - **Capacity:** 31qt to 101qt
- Finish:** silver 
- Bins:** gray 
- **Finish:** lava 
- Bins:** lava 
- **Additionally available:** VS ENVI® Kick

CABINET DIMENSIONS

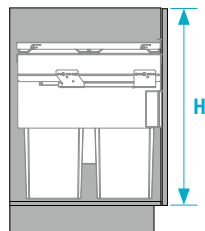
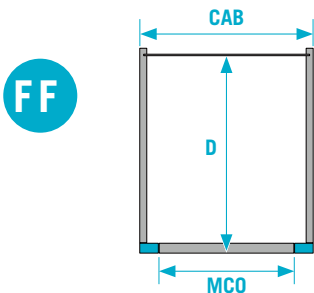

Cabinet widths (CAB)	FF cabinet opening (MCO)	Installation depth (D)	Installation height (H) VS ENVI® Space XX	Installation height (H) VS ENVI® Space XX Pro
15"	12"	20-1/2"	19-1/2"	23"
18"	15"	20-1/2"	19-1/2"	23"
21"	18"	20-1/2"	19-1/2"	23"
24"	21"	20-1/2"	19-1/2"	23"

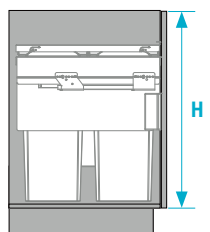
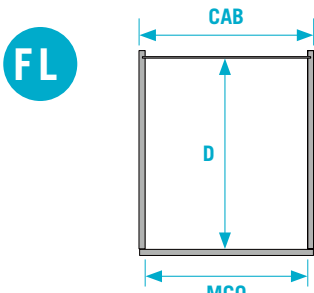

Cabinet widths (CAB)	FL cabinet opening (MCO)	Installation depth (D)	Installation height (H) VS ENVI® Space XX	Installation height (H) VS ENVI® Space XX Pro
15"	13-1/2"	20-1/2"	19-1/2"	23"
18"	16-1/2"	20-1/2"	19-1/2"	23"
21"	19-1/2"	20-1/2"	19-1/2"	23"
24"	22-1/2"	20-1/2"	19-1/2"	23"

TOP VIEW

SIDE VIEW

UNDER DRAWER

- Under cabinet / drawer waste bin
- Top mounted
- Pullouts with soft-close

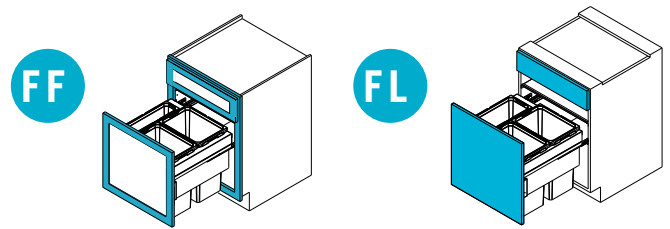

1 BIN & 1 BOX



	1./3. silver	2./4. lava	Cabinet width	Cabinet opening	Product height	Product width	Product depth	Capacity
FF	10090008742	10090008899	15"	12"	19-1/16"	13-1/2"	20-3/8"	1 bin 31qt and 1 box 1.5qt
FL	10090008738	10090008895	15"	13-1/2"	18-7/8"	13-1/2"	20-3/8"	1 bin 31qt and 1 box 1.5qt

2 BINS



	1./3. silver	2./4. lava	Cabinet width	Cabinet opening	Product height	Product width	Product depth	Capacity
FF	10090008743	10090008900	18"	15"	19-3/16"	16-1/2"	20-3/8"	2 bins 31qt
FF	10090008744	10090008901	21"	18"	19-3/16"	19-1/2"	20-3/8"	2 bins 31qt
FL	10090008739	10090008896	18"	16-1/2"	18-7/8"	16-1/2"	20-3/8"	2 bins 31qt
FL	10090008740	10090008897	21"	19-1/2"	18-7/8"	19-1/2"	20-3/8"	2 bins 31qt

3 BINS



	1./3. silver	2./4. lava	Cabinet width	Cabinet opening	Product height	Product width	Product depth	Capacity
FF	10090008745	10090008902	24"	21"	19-1/16"	22-1/2"	20-3/8"	2 bins 31qt and 1 bin 10qt
FL	10090008741	10090008898	24"	22-1/2"	18-7/8"	22-1/2"	20-3/8"	2 bins 31qt and 1 bin 22qt

FULL HEIGHT

- Full height waste bin
- Top mounted
- Pullouts with soft-close

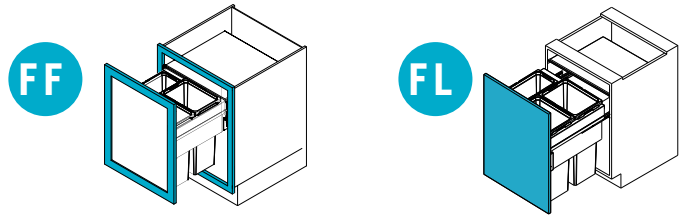

1 BIN & 1 BOX

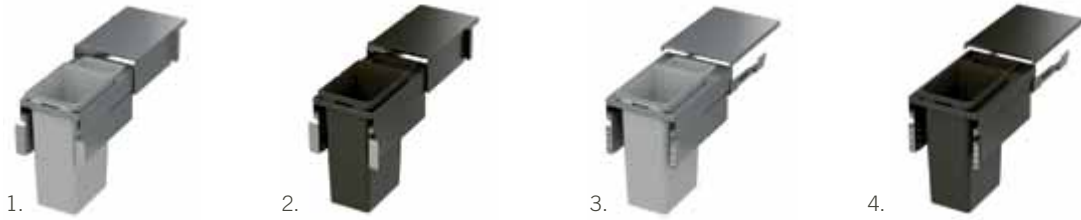

	1./3. silver	2./4. lava	Cabinet width	Cabinet opening	Product height	Product width	Product depth	Capacity
FF	10090008462	10090009903	15"	12"	22-1/6"	13-1/2"	20-3/8"	1 bin 31qt and 1 box 1.5qt
FL	10090008393	10090009899	15"	13-1/2"	22-3/4"	13-1/2"	20-3/8"	1 bin 37qt and 1 box 1.5qt

2 BINS



	1./3. silver	2./4. lava	Cabinet width	Cabinet opening	Product height	Product width	Product depth	Capacity
FF	10090008463	10090009904	18"	15"	22-5/8"	16-1/2"	20-3/8"	2 bins 31qt
FF	10090008464	10090009905	21"	18"	22-5/8"	19-1/2"	20-3/8"	2 bins 31qt
FL	10090008392	10090009900	18"	16-1/2"	22-7/16"	16-1/2"	20-3/8"	2 bins 37qt
FL	10090008391	10090009901	21"	19-1/2"	22-7/16"	19-1/2"	20-3/8"	2 bins 37qt

3 BINS



	1./3. silver	2./4. lava	Cabinet width	Cabinet opening	Product height	Product width	Product depth	Capacity
FF	10090008465	10090009906	24"	21"	22-5/8"	22-1/2"	20-3/8"	2 bins 31qt and 1 bin 10qt
FL	10090008390	10090009902	24"	22-1/2"	22-7/16"	22-1/2"	20-3/8"	2 bins 37qt and 1 bin 22qt

VS ENVI® WASTE LID

Available for the 21 qt bin to prevent the occurrence of bad odors.

ONLY
AVAILABLE FOR
THE SMALL 10QT BIN
IN THE FRAMELESS
TRIPLE VERSION
VS ENVI® SPACE XX PRO
VS WASH® SPACE XX PRO



1.



2.



1. gray



2. lava



10090005313

10091001514

VS ENVI® Kick KICK OPENER



SUPPLEMENT
FOR
VS ENVI® SPACE XX
VS ENVI® SPACE XX PRO
VS ENVI® BMT PLANERO
VS WASH® SPACE XX / PRO



FOR
FRAMELESS
KITCHEN

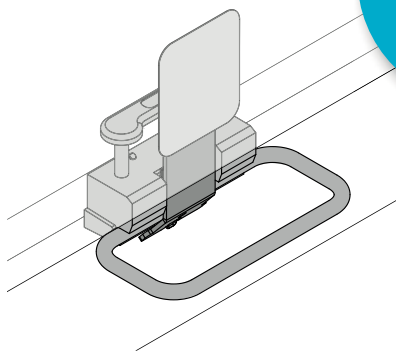

A system for a **soft** and **comfortable** opening of all front pull-outs such as the VS ENVI® Space XX. The ergonomically designed step opens the waste bin system fully with little effort. The opening **mechanism** returns automatically to its starting position.

DETAILS

VS ENVI® KICK

chrome		Minimum plinth height	Installation depth
10090006930		2-3/4"	1-1/4"

NICE AND STABLE FROM
THE GROUND UP.

FOR
FACE FRAME &
FRAMELESS
KITCHEN

VS ENVI[®] BMT Saphir
BOTTOM MOUNTED WASTE BIN



Watch it!

FEATURES



Single bin version comes with
extra storage box



Adjustable security rods



Installation template for easy
and fast installation



Easy bottom
mount installation

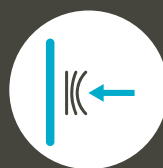

Integrated soft and
self-closing



Retrofit ready
can be installed in existing cabinetry
without removing the countertop

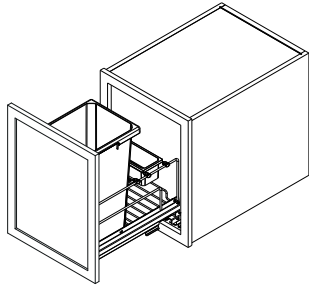

DETAILS

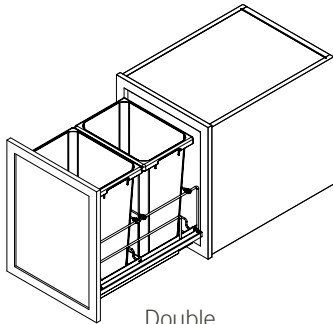

Single



Double

- **Cabinet widths (CAB):** 15" and 18"
- **FF**
- **Cabinet opening (MCO):**
 - Single version: 12"
 - Double version: 15"
- **FF width:** 1-1/2"
- **FL**
- **Cabinet opening (MCO):**
 - Single version: min. 13"
 - Double version: min. 16"
- **Installation depth:** min. 22-1/2"
- **Installation height:**
 - 35qt: 20-1/2"
 - 50qt: 24"
- **Capacity:**
 - Single version: 35 or 50qt
 - Double version: 70 or 100qt
- **Finish:**
 - silver 
 - Bins: gray 
 - lava 
 - Bins: lava 

CABINET DIMENSIONS

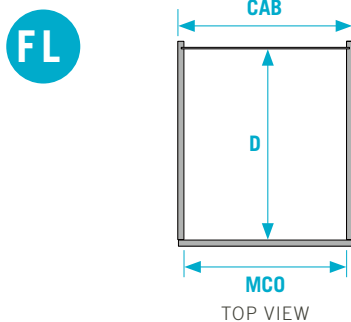
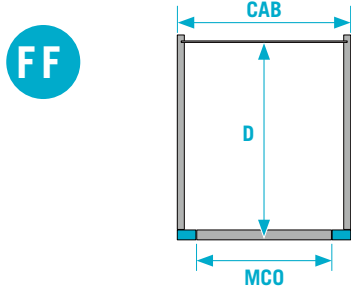

Cabinet widths (CAB)	FF cabinet opening (MCO)	Installation depth (D)	Installation height 35qt	Installation height 50qt
15"	12"	22-1/2"	20-1/2"	24"
18"	15"	22-1/2"	20-1/2"	24"

Cabinet widths (CAB)	FL cabinet opening (MCO)	Installation depth (D)	Installation height 35qt	Installation height 50qt
min. 14.5"	min. 13"	22-1/2"	20-1/2"	24"
min. 17.5"	min. 16"	22-1/2"	20-1/2"	24"



35 QT - UNDER DRAWER Flatpacked

- Under cabinet / drawer waste bin
- Bottom-mounted
- Pullouts with soft-close

SINGLE BIN 35qt

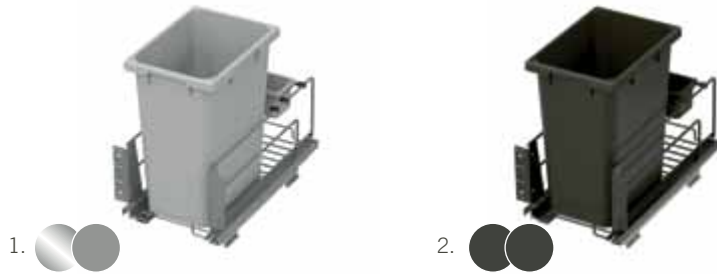

Item #	Cabinet width	FF cabinet opening	FL cabinet opening	Installation depth	Installation height	Capacity	Finish Fitting / Bins
90092000117	15"	min. 12"	min. 13"	22-1/2"	20-1/2"	1 bin 35qt and 1 box 1.5qt	1. silver / gray
90092000101	15"	min. 12"	min. 13"	22-1/2"	20-1/2"	1 bin 35qt and 1 box 1.5qt	2. lava / lava

DOUBLE BIN 35qt



Item #	Cabinet width	FF cabinet opening	FL cabinet opening	Installation depth	Installation height	Capacity	Finish Fitting / Bins
90092000119	18"	min. 15"	min. 16"	22-1/2"	20-1/2"	2 bins 35qt	3. silver / gray
90092000103	18"	min. 15"	min. 16"	22-1/2"	20-1/2"	2 bins 35qt	4. lava / lava



50 QT - FULL HEIGHT Flatpacked

- Full height waste bin
- Bottom mounted
- Pullouts with soft-close

SINGLE BIN 50qt

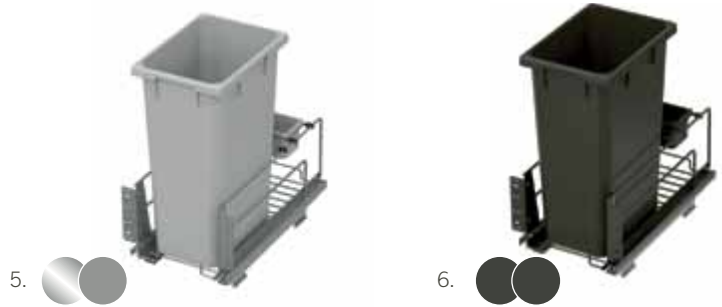

Item #	Cabinet width	FF cabinet opening	FL cabinet opening	Installation depth	Installation height	Capacity	Finish Fitting / Bins
90092000118	15"	min. 12"	min. 13"	22-1/2"	24"	1 bin 50qt and 1 box 1.5qt	5. silver / gray
90092000102	15"	min. 12"	min. 13"	22-1/2"	24"	1 bin 50qt and 1 box 1.5qt	6. lava / lava

DOUBLE BIN 50qt



Item #	Cabinet width	FF cabinet opening	FL cabinet opening	Installation depth	Installation height	Capacity	Finish Fitting / Bins
90092000120	18"	min. 15"	min. 16"	22-1/2"	24"	2 bins 50qt	7. silver / gray
90092000104	18"	min. 15"	min. 16"	22-1/2"	24"	2 bins 50qt	8. lava / lava



35 QT - UNDER DRAWER Preassembled

- Under cabinet / drawer waste bin
- Bottom-mounted
- Pullouts with soft-close



SINGLE BIN 35qt

1.



2.



Item #	Cabinet width	FF cabinet opening	FL cabinet opening	Installation depth	Installation height	Capacity	Finish Fitting / Bins
90098000005	15"	min. 12"	min. 13"	22-1/2"	20-1/2"	1 bin 35qt and 1 box 1.5qt	1. silver / gray
90098000001	15"	min. 12"	min. 13"	22-1/2"	20-1/2"	1 bin 35qt and 1 box 1.5qt	2. lava / lava



DOUBLE BIN 35qt

3.



4.



Item #	Cabinet width	FF cabinet opening	FL cabinet opening	Installation depth	Installation height	Capacity	Finish Fitting / Bins
90098000007	18"	min. 15"	min. 16"	22-1/2"	20-1/2"	2 bins 35qt	3. silver / gray
90098000003	18"	min. 15"	min. 16"	22-1/2"	20-1/2"	2 bins 35qt	4. lava / lava

BULK PACKAGES

Packing unit of 20 preassembled VS ENVI® BMT Saphir without bins

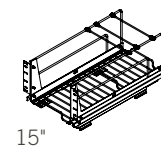

15"

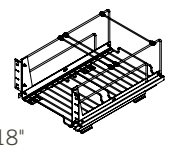

18"

Item # silver	Item # lava	Cabinet width	FF cabinet opening	FL cabinet opening	Installation depth
10090010290	10090010289	15"	min. 12"	min. 13"	22-1/2"
10090010292	10090010291	18"	min. 15"	min. 16"	22-1/2"



50 QT - FULL HEIGHT Preassembled

- Full height waste bin
- Bottom mounted
- Pullouts with soft-close



SINGLE BIN 50qt

Item #	Cabinet width	FF cabinet opening	FL cabinet opening	Installation depth	Installation height	Capacity	Finish Fitting / Bins
90098000006	15"	min. 12"	min. 13"	22-1/2"	24"	1 bin 50qt and 1 box 1.5qt	5. silver / gray
90098000002	15"	min. 12"	min. 13"	22-1/2"	24"	1 bin 50qt and 1 box 1.5qt	6. lava / lava



DOUBLE BIN 50qt

Item #	Cabinet width	FF cabinet opening	FL cabinet opening	Installation depth	Installation height	Capacity	Finish Fitting / Bins
90098000008	18"	min. 15"	min. 16"	22-1/2"	24"	2 bins 50qt	7. silver / gray
90098000004	18"	min. 15"	min. 16"	22-1/2"	24"	2 bins 50qt	8. lava / lava



SINGLE BINS

Available for VS ENVI® BMT Saphir and Planero®

	gray	lava	Description
1.	10090005833	10090009117	1.5qt box
2.	90054000001	90054000034	35qt bin
3.	90054000002	90054000035	50qt bin



PREFERABLY CUSTOMISED
ON THE INSIDE.

FOR
FACE FRAME &
FRAMELESS
KITCHEN

VS ENVI® BMT Planero
BOTTOM MOUNTED WASTE BIN
WITH OPTIONAL SIDE PANELS



Watch it!

FEATURES



Single bin version comes with
extra storage box



Synchronised runners with
over extension



Exchangeable side panels



EasyFit

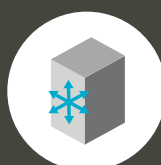

3D front adjustment

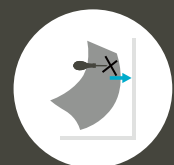

Installation template for easy
and fast installation

DETAILS

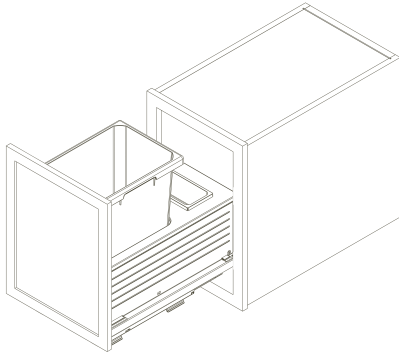

Single

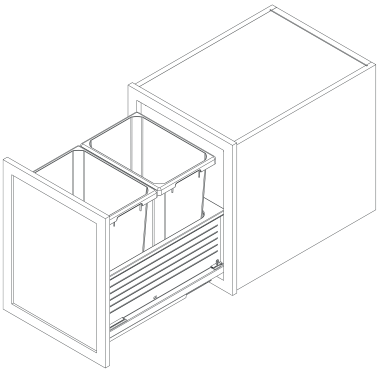

Double

- **Cabinet widths (CAB):** 15" and 18"
- **FF**
 - **Cabinet opening (MCO):**
 - Single version: 12"
 - Double version: 15"
 - **FF width:** 1-1/2"
- **FL**
 - **Cabinet opening (MCO):**
 - Single version: min. 13"
 - Double version: min. 16"
- **Installation depth:** min. 22-1/2"
- **Installation height:**
 - 35qt: 20-1/2"
 - 50qt: 24"
- **Capacity:**
 - Single version: 35 or 50qt
 - Double version: 70 or 100qt
- **Finish:**
 - silver 
 - Bins:** gray 
- **Finish:**
 - lava 
 - Bins:** lava 
- **Panels:**
 - maple 
 - walnut 

CABINET DIMENSIONS

FF

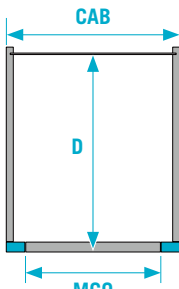

Cabinet widths (CAB)	FF cabinet opening (MCO)	Installation depth (D)	Installation height 35qt	Installation height 50qt
15"	12"	22-1/2"	20-1/2"	24"
18"	15"	22-1/2"	20-1/2"	24"

FL

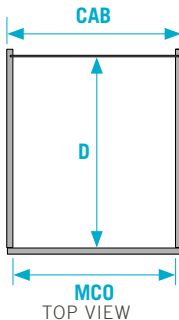

Cabinet widths (CAB)	FL cabinet opening (MCO)	Installation depth (D)	Installation height 35qt	Installation height 50qt
min. 14.5"	min. 13"	22-1/2"	20-1/2"	24"
min. 17.5"	min. 16"	22-1/2"	20-1/2"	24"

EXCLUDING SIDE PANELS

SINGLE BIN 35qt and 50qt



Item #	Cabinet width FF / FL	FF cabinet opening	FL cabinet opening	Installation depth	Installation height	Capacity	Finish Frame / Bins
90092000121	15" / min. 14-1/2"	min. 12"	min. 13"	22-1/2"	20-1/2"	1 bin 35qt and 1 box 1.5qt	1. silver / gray
90092000105	15" / min. 14-1/2"	min. 12"	min. 13"	22-1/2"	20-1/2"	1 bin 35qt and 1 box 1.5qt	2. lava / lava
90092000122	15" / min. 14-1/2"	min. 12"	min. 13"	22-1/2"	24"	1 bin 50qt and 1 box 1.5qt	3. silver / gray
90092000106	15" / min. 14-1/2"	min. 12"	min. 13"	22-1/2"	24"	1 bin 50qt and 1 box 1.5qt	4. lava / lava

DOUBLE BIN 70qt and 100qt



Item #	Cabinet width FF / FL	FF cabinet opening	FL cabinet opening	Installation depth	Installation height	Capacity	Finish Frame / Bins
90092000123	18" / min. 17-1/2"	min. 15"	min. 16"	22-1/2"	20-1/2"	2 bins 35qt	5. silver / gray
90092000107	18" / min. 17-1/2"	min. 15"	min. 16"	22-1/2"	20-1/2"	2 bins 35qt	6. lava / lava
90092000124	18" / min. 17-1/2"	min. 15"	min. 16"	22-1/2"	24"	2 bins 50qt	7. silver / gray
90092000108	18" / min. 17-1/2"	min. 15"	min. 16"	22-1/2"	24"	2 bins 50qt	8. lava / lava

CUSTOMIZE YOUR PANELS

- 1 Side panels can be made of solid wood, melamine or laminate panels.
- 2 Cut your side panel to the size:
 - Panel Size: 21.85"W x 7.60"H x 0.31" Thick
 - Dimension of Groove Deep = 0.21" Deep x 0.09" Groove Width
- 3 Slide the side panel into your unit for a customized look.



INCLUDING SIDE PANELS



Item #	Cabinet width FF / FL	FF cabinet opening	FL cabinet opening	Installation depth	Installation height	Capacity	Finish Frame / Bins / Side panels
90092000125	15" / min. 14-1/2"	min. 12"	min. 13"	22-1/2"	20-1/2"	1 bin 35qt and 1 box 1.5qt	1. silver / gray / maple
90092000109	15" / min. 14-1/2"	min. 12"	min. 13"	22-1/2"	20-1/2"	1 bin 35qt and 1 box 1.5qt	2. lava / lava / maple
90092000110	15" / min. 14-1/2"	min. 12"	min. 13"	22-1/2"	20-1/2"	1 bin 35qt and 1 box 1.5qt	3. lava / lava / walnut
90092000126	15" / min. 14-1/2"	min. 12"	min. 13"	22-1/2"	24"	1 bin 50qt and 1 box 1.5qt	4. silver / gray / maple
90092000111	15" / min. 14-1/2"	min. 12"	min. 13"	22-1/2"	24"	1 bin 50qt and 1 box 1.5qt	5. lava / lava / maple
90092000112	15" / min. 14-1/2"	min. 12"	min. 13"	22-1/2"	24"	1 bin 50qt and 1 box 1.5qt	6. lava / lava / walnut



Item #	Cabinet width FF / FL	FF cabinet opening	FL cabinet opening	Installation depth	Installation height	Capacity	Finish Frame / Bins / Side panels
90092000127	18" / min. 17-1/2"	min. 15"	min. 16"	22-1/2"	20-1/2"	2 bins 35qt	7. silver / gray / maple
90092000113	18" / min. 17-1/2"	min. 15"	min. 16"	22-1/2"	20-1/2"	2 bins 35qt	8. lava / lava / maple
90092000114	18" / min. 17-1/2"	min. 15"	min. 16"	22-1/2"	20-1/2"	2 bins 35qt	9. lava / lava / walnut
90092000128	18" / min. 17-1/2"	min. 15"	min. 16"	22-1/2"	24"	2 bins 50qt	10. silver / gray / maple
90092000115	18" / min. 17-1/2"	min. 15"	min. 16"	22-1/2"	24"	2 bins 50qt	11. lava / lava / maple
90092000116	18" / min. 17-1/2"	min. 15"	min. 16"	22-1/2"	24"	2 bins 50qt	12. lava / lava / walnut

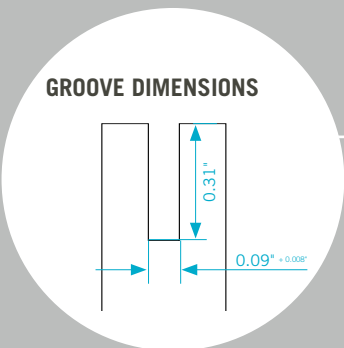

Your design

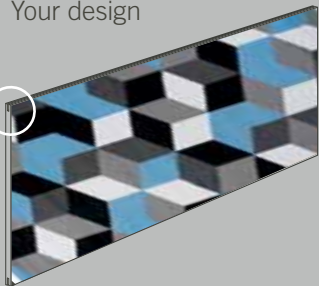

WOOD IN ITS MOST PERFECT FORM.

FOR
FACE FRAME &
FRAMELESS
KITCHEN

VS ENVI[®] BMT Ligano BOTTOM MOUNTED WASTE BIN

FEATURES



Single bin version comes with
extra storage box



Synchronised runners with
over extension

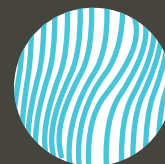

Uniform veneer appearance



Installation on the guides without
the need for tools



3D front adjustment

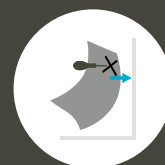

Installation template for easy
and fast installation

DETAILS

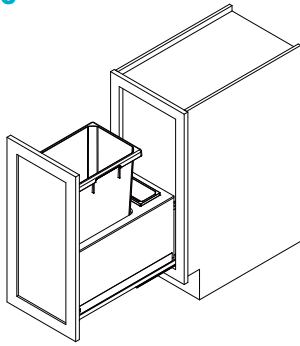

Single

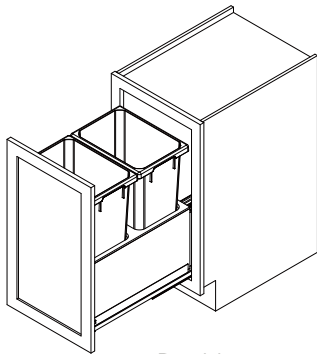

Double

- **Cabinet widths (CAB):** 15" and 18"

FF

- **Cabinet opening (MCO):**
 Single version: 12"
 Double version: 15"
- **FF width:** 1-1/2"

FL

- **Cabinet opening (MCO):**
 Single version: min. 13"
 Double version: min. 16"
- **Installation depth:** min. 22-1/2"
- **Installation height:**
 35qt: 20-1/2"
 50qt: 24"
- **Capacity:**
 Single version: 35 or 50qt
 Double version: 70 or 100qt

- **Finish:** platinum / wood
- **Bins:** gray
- **Finish:** lava / wood
- **Bins:** lava



CABINET DIMENSIONS

FF

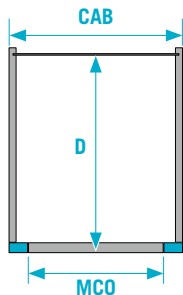

Cabinet widths (CAB)	FF cabinet opening (MCO)	Installation depth (D)	Installation height 35qt	Installation height 50qt
15"	12"	22-1/2"	20-1/2"	24"
18"	15"	22-1/2"	20-1/2"	24"

FL

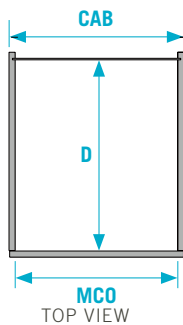

Cabinet widths (CAB)	FL cabinet opening (MCO)	Installation depth (D)	Installation height 35qt	Installation height 50qt
min. 14-1/2"	min. 13"	22-1/2"	20-1/2"	24"
min. 17-1/2"	min. 16"	22-1/2"	20-1/2"	24"

35 QT - UNDER DRAWER Preassembled

- Under cabinet/drawer waste bin
- Bottom-mounted
- Pullouts with soft-close



1.



2.

SINGLE BIN 35qt

Item #	Cabinet width	FF cabinet opening	FL cabinet opening	Installation depth	Installation height	Capacity	Finish / Fitting / Bins
*	15"	min. 12"	min. 13"	22-1/2"	20-1/2"	1 bin 35qt and 1 box 1.5qt	1. platinum / wood / gray
*	15"	min. 12"	min. 13"	22-1/2"	20-1/2"	1 bin 35qt and 1 box 1.5qt	2. lava / wood / lava



3.



4.

DOUBLE BIN 35qt

Item #	Cabinet width	FF cabinet opening	FL cabinet opening	Installation depth	Installation height	Capacity	Finish / Fitting / Bins
*	18"	min. 15"	min. 16"	22-1/2"	20-1/2"	2 bins 35qt	3. platinum / wood / gray
*	18"	min. 15"	min. 16"	22-1/2"	20-1/2"	2 bins 35qt	4. lava / wood / lava

* Item number follows

50 QT - FULL HEIGHT Preassembled

- Full height waste bin
- Bottom mounted
- Pullouts with soft-close



5.



6.

SINGLE BIN 50qt

Item #	Cabinet width	FF cabinet opening	FL cabinet opening	Installation depth	Installation height	Capacity	Finish / Fitting / Bins
*	15"	min. 12"	min. 13"	22-1/2"	24"	1 bin 50qt and 1 box 1.5qt	5. platinum / wood / gray
*	15"	min. 12"	min. 13"	22-1/2"	24"	1 bin 50qt and 1 box 1.5qt	6. lava / wood / lava



7.



8.

DOUBLE BIN 50qt

Item #	Cabinet width	FF cabinet opening	FL cabinet opening	Installation depth	Installation height	Capacity	Finish / Fitting / Bins
*	18"	min. 15"	min. 16"	22-1/2"	24"	2 bins 50qt	7. platinum / wood / gray
*	18"	min. 15"	min. 16"	22-1/2"	24"	2 bins 50qt	8. lava / wood / lava

* Item number follows

VS
COR



VS COR® — CORNER CABINETS

A corner cabinet is not simply a cabinet placed in a corner. With this conceptual approach, we have developed cabinet solutions that not only optimally utilize angled spaces, but instead put

the corner right in the centre of the kitchen experience. As a result, we open up unseen perspectives in the kitchen and allow people to experience space in a new way.

THE MAXXIMUM IN INNOVATION.

FOR
FACE FRAME &
FRAMELESS
KITCHEN



Watch it!

VS CORNERSTONE® Maxx

BLIND CORNER WITH INDEPENDENT TRAYS

FEATURES



PAM: Optional
Power-Assisted Movement



Independent movement of trays

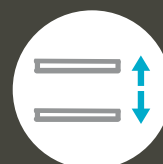

Simple height adjustment,
even when installed



Unhandled installation



Three simple installation steps



Fewer parts – less warehousing

DETAILS

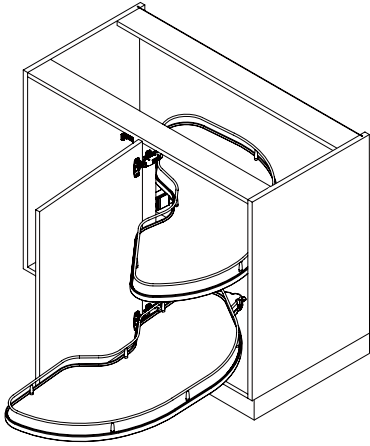

- **Cabinet widths (CAB):** 36" and 39"
- **Cabinet opening (MCO):**
 - FF 15", 18" and 21"
 - FL 16-11/16", 18-11/16" and 22-5/8"
- **FF width:** 1-1/2"
- **Installation height:**
 - 2 trays 25-1/5" to 33-1/2"
 - 4 trays 53" to 63"
- **Installation depth:** min. 19-1/2"
- **Load capacity:** max. 55lbs per tray
- **Storage versions:** Scalea and Planero®

HARDWARE UNIT
ONE FOR ALL
TRAYS
HANDED

- **Finish:**
 - platinum
 - maple
 - lava
 - maple
 - lava
 - walnut
 - lava
 - lava

CABINET DIMENSIONS

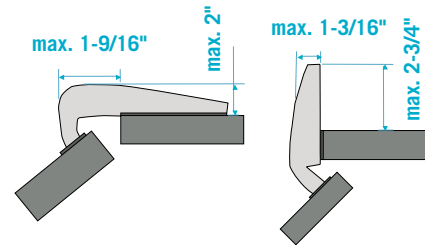
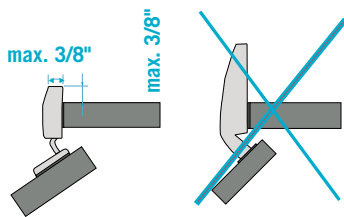
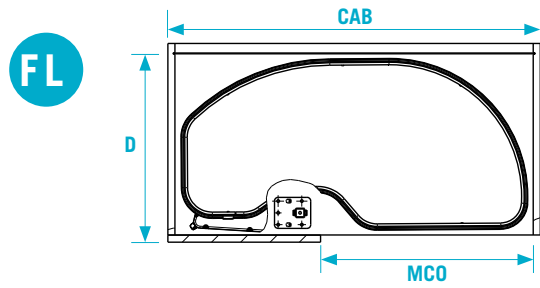
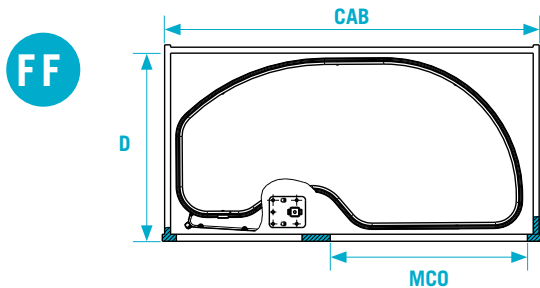

Tray size	Cabinetwidths (CAB)	FF cabinet opening (MCO)	FL cabinet opening (MCO)	Installation depth (D)	Installation height (2 trays)	Installation height (4 trays)
15"	36"	15"	16-11/16"	19-1/2"	min 25-13/16"	min 53"
18"	39"	18"	18-11/16"	19-1/2"	min 25-13/16"	min 53"
21"	39"	21"	22-5/8"	19-1/2"	min 25-13/16"	min 53"

TWO TRAY VARIATIONS SETS



1. Scalea platinum / maple



2. Scalea lava / maple



3. Scalea lava / walnut



4. Scalea lava / lava

SCALEA



1. platinum / maple
Fitting: silver



2. lava / maple
Fitting: lava



3. lava / walnut
Fitting: lava



4. lava
Fitting: lava

				Tray size	Cabinet widths	FF cabinet opening	FL cabinet opening	Installation side
90092000047	90092000019	90092000021	90092000017	15"	36"	15"	16-11/16"	Left
90092000048	90092000020	90092000022	90092000018	15"	36"	15"	16-11/16"	Right
90092000049	90092000029	90092000031	90092000027	18"	39"	18"	18-11/16"	Left
90092000050	90092000030	90092000032	90092000028	18"	39"	18"	18-11/16"	Right
90092000051	90092000039	90092000041	90092000037	21"	39"	21"	22-5/8"	Left
90092000052	90092000040	90092000042	90092000038	21"	39"	21"	22-5/8"	Right



5. Planero® lava / walnut



6. Planero® lava / lava

PLANERO®



5. lava / walnut
Fitting: lava



6. lava / lava
Fitting: lava

				Tray size	Cabinet widths	FF cabinet opening	FL cabinet opening	Installation side
90092000025	90092000023			15"	36"	15"	16-11/16"	Left
90092000026	90092000024			15"	36"	15"	16-11/16"	Right
90092000035	90092000033			18"	39"	18"	18-11/16"	Left
90092000036	90092000034			18"	39"	18"	18-11/16"	Right
90092000045	90092000043			21"	39"	21"	22-5/8"	Left
90092000046	90092000044			21"	39"	21"	22-5/8"	Right

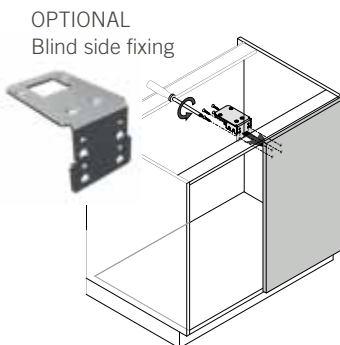

OPTIONAL
Blind side fixing

Blind side fixing
Item #



10090007928

FOUR TRAY VARIATIONS SETS

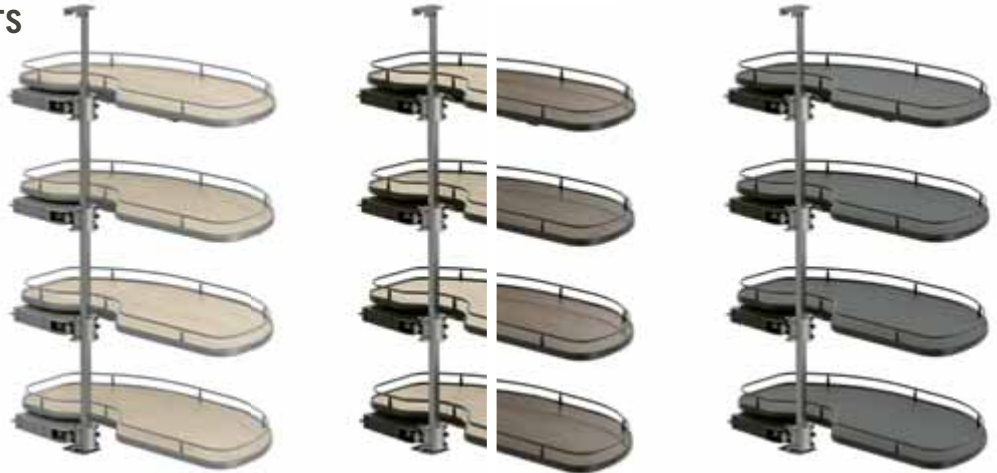

1. Scalea platinum / maple 2. Scalea lava / maple 3. Scalea lava / walnut 4. Scalea lava / lava

SCALEA



1. platinum / maple
Fitting: silver



2. lava / maple
Fitting: lava



3. lava / walnut
Fitting: lava



4. lava
Fitting: lava

				Tray size	Cabinet widths	FF cabinet opening	FL cabinet opening	Installation side
*	*	*	*	15"	36"	15"	16-11/16"	Left
*	*	*	*	15"	36"	15"	16-11/16"	Right
*	*	*	*	18"	39"	18"	18-11/16"	Left
*	*	*	*	18"	39"	18"	18-11/16"	Right
*	*	*	*	21"	39"	21"	22-5/8"	Left
*	*	*	*	21"	39"	21"	22-5/8"	Right



5. Planero® lava / walnut

6. Planero® lava / lava

PLANERO®



5. lava / walnut
Fitting: lava



6. lava / lava
Fitting: lava

		Tray size	Cabinet widths	FF cabinet opening	FL cabinet opening	Installation side
*	*	15"	36"	15"	16-11/16"	Left
*	*	15"	36"	15"	16-11/16"	Right
*	*	18"	39"	18"	18-11/16"	Left
*	*	18"	39"	18"	18-11/16"	Right
*	*	21"	39"	21"	22-5/8"	Left
*	*	21"	39"	21"	22-5/8"	Right

* Item number follows

THE CORNER IN THE CENTRE.

FOR
FACE FRAME &
FRAMELESS
KITCHEN



Watch it!

VS CORNERSTONE® Swing BLIND CORNER WITH DOOR-MOUNTED LOWER TRAY

FEATURES



Independent movement of trays



L-Movement



Door-mounted lower tray



Optional soft close



Unhandled installation





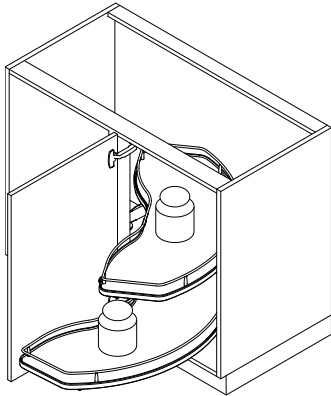

Easy assembly

DETAILS



- **Cabinet widths (CAB):** 36" and 39"
- **Cabinet opening (MCO):**
 - FF 18", 21" and 24"
 - FL 18", 21" and 24"
- **FF width:** 1-1/2"
- **Installation height:**
 - Size 1: 24"-25-5/8"
 - Size 2: 25-5/8"-27-1/4"
 - Size 3: 27-1/4"-28-11/16"
 - Size 4: 28-11/16"-305/16"
- **Installation depth:** min. 19-5/16"
- **Load capacity:** max. 40lbs per tray
- **Storage version:** Scalea

- **Finish:**
 - Platinum  Lava 
 - Maple  Maple 
 - Lava  Lava 
 - Maple  

SAME
PRODUCT FOR
LEFT & RIGHT
INSTALLATION

CABINET DIMENSIONS

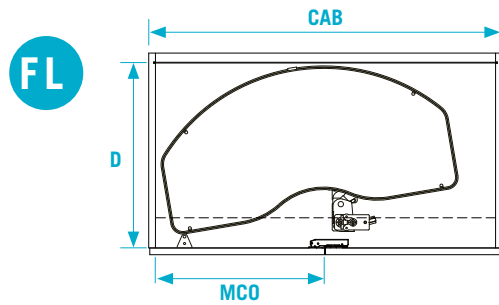
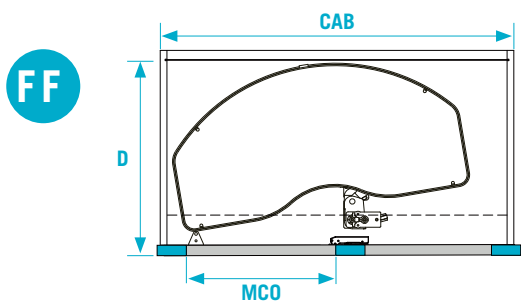

Tray size	Cabinet widths (CAB)	Cabinet opening (MCO)	Installation depth (D)	Installation height (Size 1)	Installation height (Size 2)	Installation height (Size 3)	Installation height (Size 4)
18"	36"	18"	19-1/2"	min. 24"	min 25-5/8"	min 27-3/16"	min 28-11/16"
21"	39"	21"	19-1/2"	min. 24"	min 25-5/8"	min 27-3/16"	min 28-11/16"
24"	39"	24"	19-1/2"	min. 24"	min 25-5/8"	min 27-3/16"	min 28-11/16"

TWO TRAY SETS



1. Scalea platinum / maple



2. Scalea lava / maple



3. Scalea lava / walnut



4. Scalea lava / lava

SCALEA SIZE 1 Installation Height 24"-25-5/8"

1. platinum / maple Fitting: silver	2. lava / maple Fitting: lava	3. lava / walnut Fitting: lava	4. lava / lava Fitting: lava	Tray size	Cabinet widths	Cabinet opening
90092000062	90092000056	90092000059	90092000053	18"	36"	18"
90092000063	90092000057	90092000060	90092000054	21"	39"	21"
90092000064	90092000058	90092000061	90092000055	24"	39"	24"

SCALEA SIZE 2 Installation Height 25-5/8"-27-1/4"

1. platinum / maple Fitting: silver	2. lava / maple Fitting: lava	3. lava / walnut Fitting: lava	4. lava / lava Fitting: lava	Tray size	Cabinet widths	Cabinet opening
90092000074	90092000068	90092000071	90092000065	18"	36"	18"
90092000075	90092000069	90092000072	90092000066	21"	39"	21"
90092000076	90092000070	90092000073	90092000067	24"	39"	24"

SCALEA SIZE 3 Installation Height 27-1/4"-28-11/16"

1. platinum / maple Fitting: silver	2. lava / maple Fitting: lava	3. lava / walnut Fitting: lava	4. lava / lava Fitting: lava	Tray size	Cabinet widths	Cabinet opening
90092000086	90092000080	90092000083	90092000077	18"	36"	18"
90092000087	90092000081	90092000084	90092000078	21"	39"	21"
90092000088	90092000082	90092000085	90092000079	24"	39"	24"

SCALEA SIZE 4 Installation Height 28-11/16"-30-5/16"

1. platinum / maple Fitting: silver	2. lava / maple Fitting: lava	3. lava / walnut Fitting: lava	4. lava / lava Fitting: lava	Tray size	Cabinet widths	Cabinet opening
90092000098	90092000092	90092000095	90092000089	18"	36"	18"
90092000099	90092000093	90092000096	90092000090	21"	39"	21"
90092000100	90092000094	90092000097	90092000091	24"	39"	24"

COMPARISON

HANDED / UNHANDED

HEIGHT ADJUSTABILITY OF TRAYS

SOFT-CLOSE

AMOUNT OF BUILT-IN PARTS FIXED TO CABINET

VS CORNERSTONE® MAXX

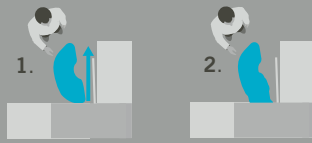

1. No blocking of neighboring cabinet
2. Trays can be moved independently

unhanded hardware
handed trays

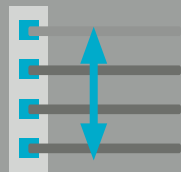

grid



2

VS

VS CORNERSTONE® SWING

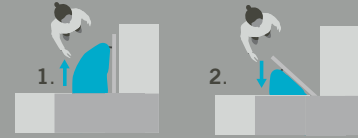

- 1./2. Lower tray automatically slides in/out when cabinet is closed/opened

unhanded hardware
unhanded trays

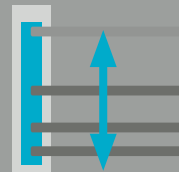

stepless

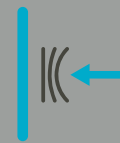

3



ACCESS TO EVERY CORNER.

FOR
FACE FRAME &
FRAMELESS
KITCHEN



Watch it!

VS COR® Flex

BLIND CORNER PULL-OUT WITH 100% ACCESS

FEATURES



Maximum access



Lock-system



Integrated soft and
self-closing



Unhanded installation





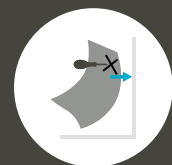



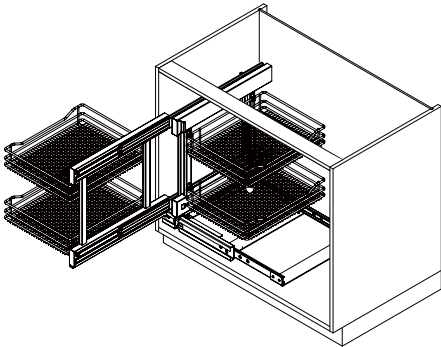

Easy bottom
mount installation



Installation template for easy
and fast installation

DETAILS



- **Cabinet widths (CAB):** 36" and 39"
- **Cabinet opening (MCO):**
 - FF 15" and 17-1/2"
 - FL 15" and 17-1/2"
- **Installation height:** min. 22-3/5"
- **Installation depth:** 23"
- **Load capacity:** max. 70lbs per tray
- **Storage versions:** Saphir, Scalea and Planero®
- **Finish:**
 - platinum 
 - maple 
 - lava 
 - maple 
 - lava 
 - walnut 
 - lava 
 - lava 

SAME
PRODUCT FOR
LEFT & RIGHT
INSTALLATION

CABINET DIMENSIONS

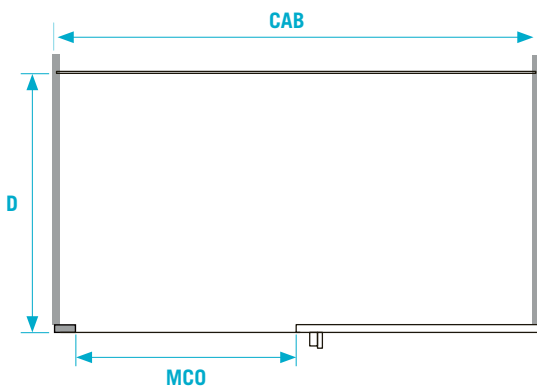

Top View

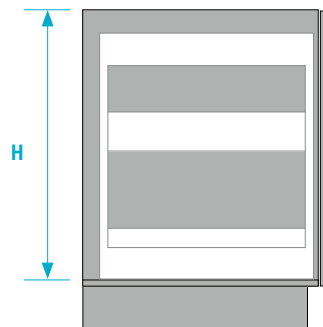

Side View

Cabinet widths (CAB) Cabinet opening (MCO) Installation depth (D) Installation height (H)

36"	15"	23"	min. 22-5/8"
39"	17-1/2"	23"	min. 22-5/8"

FOUR TRAY SETS



1. Saphir platinum



2. Saphir lava

SAPHIR



1. platinum
Fitting: silver



2. lava
Fitting: lava

		Cabinet width	Cabinet opening	Basket width (front)	Basket width (back)	Basket Set
90092000013	90092000001	36"	15"	11"	11"	4
90092000015	90092000007	39"	17-1/2"	13-3/4"	12-13/16"	4



3. Scalea platinum / maple



4. Scalea lava / maple



5. Scalea lava / walnut



6. Scalea lava / lava

SCALEA



3. platinum / maple
Fitting: silver



4. lava / maple
Fitting: lava



5. lava / walnut
Fitting: lava



6. lava / lava
Fitting: lava

				Cabinet width	Cabinet opening	Basket width (front)	Basket width (back)	Basket Set
90092000014	90092000003	90092000004	90092000002	36"	15"	11"	11"	4
90092000016	90092000009	90092000010	90092000008	39"	17-1/2"	13-3/4"	12-13/16"	4

FOUR TRAY SETS



7. Planero® lava / walnut



8. Planero® lava / lava

PLANERO®



7. lava / walnut
Fitting: lava



8. lava / lava
Fitting: lava

		Cabinet width	Cabinet opening	Tray width (front)	Tray width (back)	Tray Set
90092000005	90092000006	36"	15"	11"	11"	4
90092000011	90092000012	39"	17-1/2"	13-3/4"	12-13/16"	4



EVERYTHING REVOLVES AROUND YOU.

FOR
FACE FRAME &
FRAMELESS
KITCHEN

VS COR® Wheel Pro FLOATING LAZY SUSAN



Watch it!

FEATURES



Optimal access

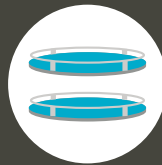

Floating design
no center pole

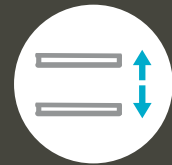

Simple height adjustment,
even when installed



High load capacity



Retrofit ready
can be installed in existing cabinetry
without removing the countertop.



Tool-free connection
of trays onto the support arms

DETAILS

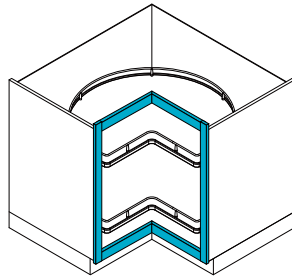

KIDNEY

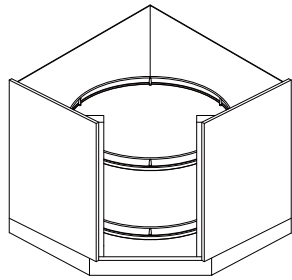

FULLROUND

- **Cabinet widths (CAB):** 32" x 32"
36 x 36"
- **Cabinet opening (MCO):**
 - Kidney** 9-1/4" or 12.68"
 - Fullround** 15-1/2" or 19.06"
- **Installation height:** min. 25-3/4"
- **Installation depth:** min. 29-3/8" or 32.16"
- **Load capacity:** 60lbs per shelf
- **Unit versions:** **Kidney** and **Fullround**
- **Storage versions:** Scalea and Planero®

- **Finish:**
 - platinum 
 - maple 
 - lava 
 - maple 
 - lava 
 - walnut 
 - lava 

A multiple stack of VS COR® Wheel Pro, which can be used as a pantry.

CABINET DIMENSIONS

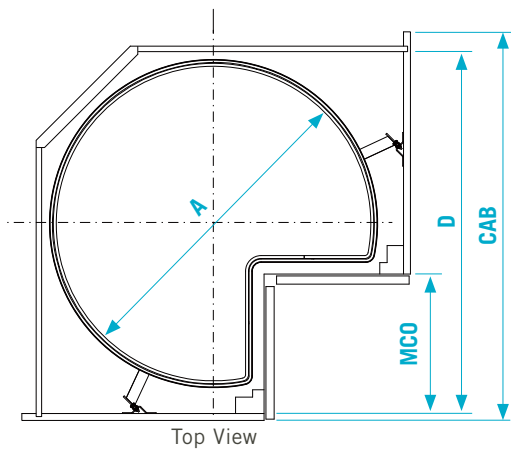

Top View

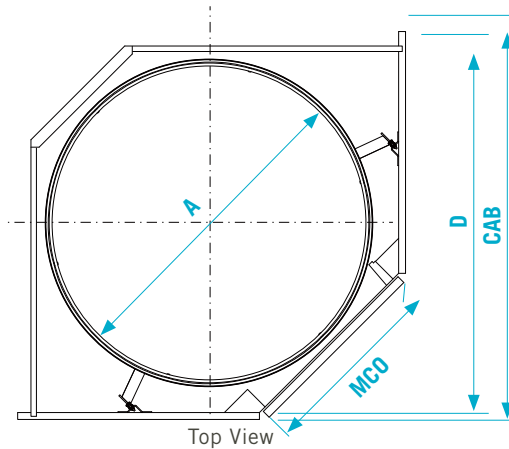

Top View

Cabinet widths (CAB)	Kidney cabinet opening (MCO)	Fullround cabinet opening (MCO)	Installation depth (D)	Installation height	Diameter (A)
32"	9-1/4"	15-1/2"	29-3/8"	25-3/4"	26-3/4"
36"	12-11/16"	19"	32-1/16"	25-3/4"	28-3/8"

KIDNEY

The VS COR® Wheel Pro Kidney comes with a set of 2 shelves.

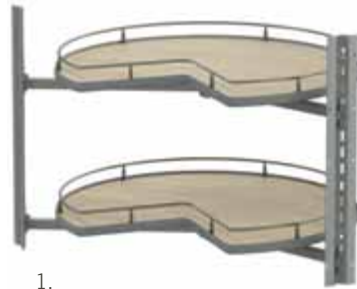

1.

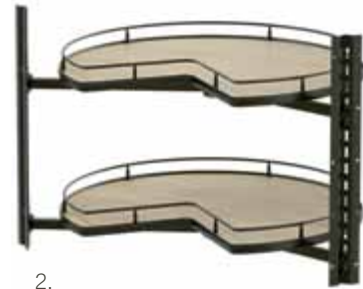

2.



3.



4.

SCALEA



4. platinum / maple
Fitting: silver



2. lava / maple
Fitting: lava



3. lava / walnut
Fitting: lava



4. lava / lava
Fitting: lava

Cabinet widths

Kidney cabinet opening

10090009569

10090008946

10090008950

10090008945

32"×32"

9-1/4"

10090009570

10090008947

10090008951

10090009092

36"×36"

12-11/16"



1.



2.

PLANERO®



1. lava / walnut
Fitting: lava



2. lava / lava
Fitting: lava

Cabinet widths

Kidney cabinet opening

10090008954

10090009095

32"×32"

9-1/4"

10090008955

10090009096

36"×36"



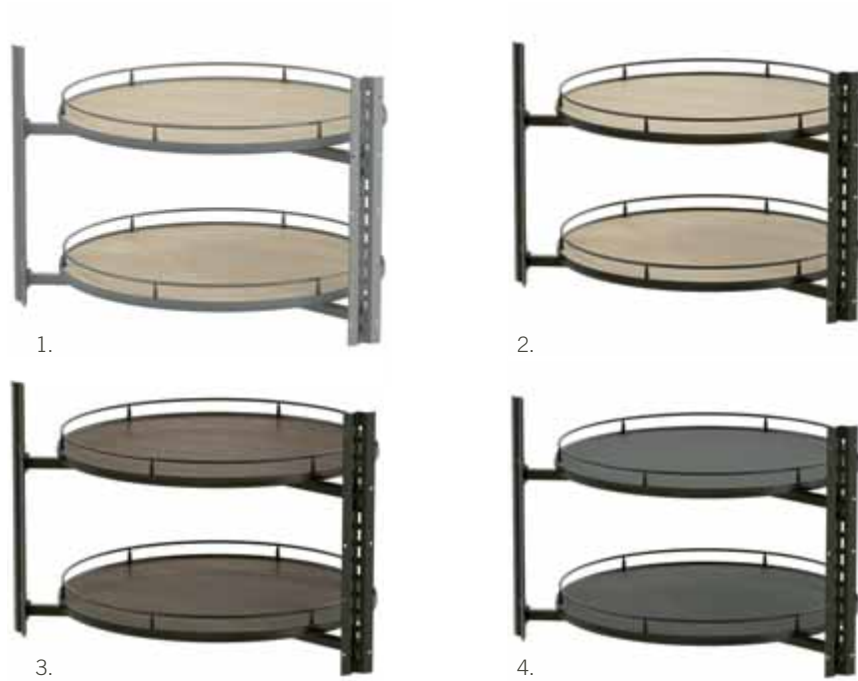

12-11/16"

FULLROUND

The VS COR® Wheel Pro Fullround comes with a set of 2 shelves.





SCALEA

 1. platinum / maple Fitting: silver	 2. lava / maple Fitting: lava	 3. lava / walnut Fitting: lava	 4. lava / lava Fitting: lava	Cabinet widths	Fullround cabinet opening
10090009571	10090008948	10090008952	10090009093	32" x 32"	15-1/2"
10090009572	10090008949	10090008953	10090009094	36" x 36"	19"



PLANERO®

 1. lava / walnut Fitting: lava	 2. lava / lava Fitting: lava	Cabinet widths	Fullround cabinet opening
10090008956	10090009097	32" x 32"	15-1/2"
10090008957	10090009098	36" x 36"	19"

YOUR PERFECT TURN

TOWARDS COMFORT.

FOR
FACE FRAME &
FRAMELESS
KITCHEN

VS COR® Susan
LAZY SUSAN

FEATURES



Ribbed shelf structure gives objects better grip and reduces noise



Assymmetric barrel guide guarantees balanced rotary motion

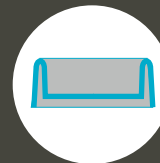

Double layer edge of shelves increases stability



High load capacity

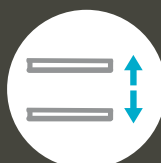

Simple height adjustment, even when installed



Retrofit ready
can be installed in existing cabinetry without removing the countertop

DETAILS – KIDNEY

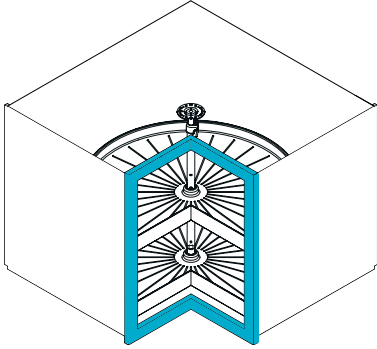

- **Cabinet widths (CAB):** 24" × 24"
27" × 27"
39" × 39"
42" × 42"
- **Cabinet opening (MCO):** 7-1/4", 10-1/4", 13-1/4" and 16-1/4"
- **Installation height:** min. 28"
- **Telescope post height:** 26" to 32"
- **Shelf size:** 18", 24", 28" and 32"
- **Load capacity:** 33lbs-66lbs per shelf
- **Unit versions:** **Kidney** polymer shelves

- **Finish:** white

DETAILS – FULLROUND

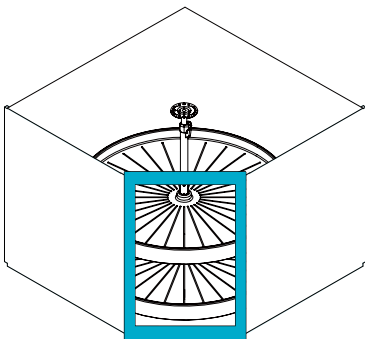

- **Cabinet widths (CAB):** 24" × 24"
33" × 33"
36" × 36"
42" × 42"
- **Cabinet opening (MCO):** 11-1/2", 15-1/2", 19-1/2" and 24"
- **Installation height:** min. 28"
- **Telescope post height:** 26" to 32"
- **Shelf size:** 18", 24", 28" and 32"
- **Load capacity:** 33lbs-66lbs per Shelf
- **Unit versions:** **Fullround** polymer shelves

- **Finish:** white

CABINET DIMENSIONS – KIDNEY

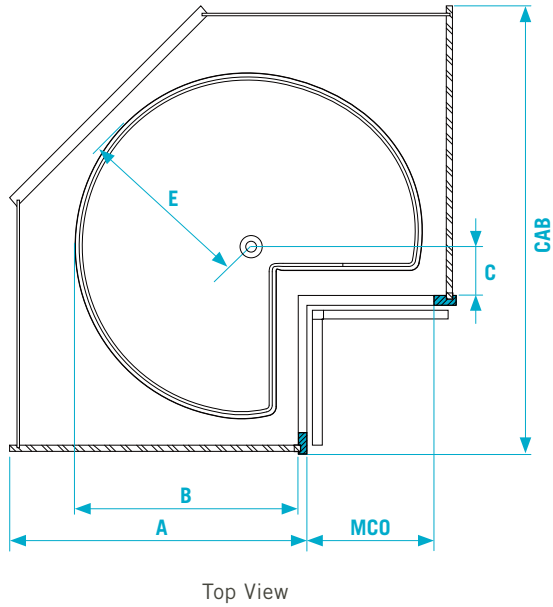

CABINET DIMENSIONS – FULLROUND

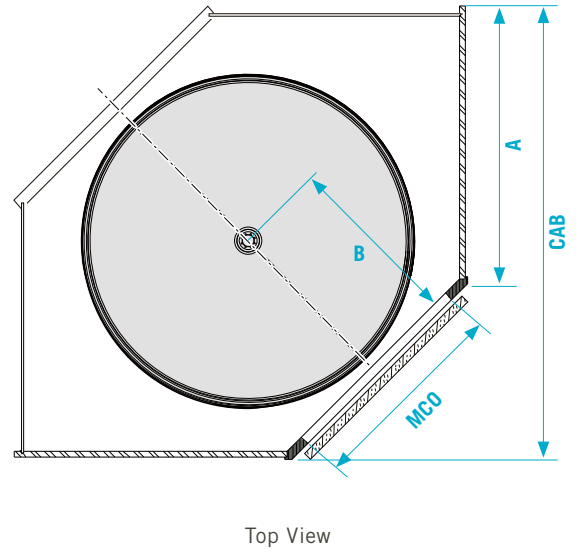

KIDNEY

Shelf size	Cabinet widths (CAB)	Cabinet opening (MCO)	A	B	C	E
18"	24"	10-1/4"	12"	10-1/16"	1"	9-1/16"
24" Large cutout	27"	10-1/4"	15"	13-5/16"	1-1/2"	11-13/16"
24" Small cutout	33"	7-1/4"	24"	15-13/16"	4"	11-13/16"
28"	36"	10-1/4"	24"	17-3/8"	3-9/16"	13-3/4"
28"	39"	13-1/4"	24"	17-3/8"	3-9/16"	13-3/4"
32"	42"	16-1/4"	24"	20-1/8"	4"	16-1/8"

FULLROUND

Shelf size	Cabinet widths (CAB)	Cabinet opening (MCO)	A	B
18"	24"	15-1/2"	12"	9-5/8"
18"	27"	15-1/2"	15"	9-5/8"
24"	33"	11-1/2"	24"	12-5/8"
28"	36"	15-1/2"	24"	14-7/8"
28"	39"	19-1/2"	24"	14-7/8"
32"	42"	24"	24"	16-11/16"

KIDNEY

The VS COR® Susan Kidney includes a set of 2 shelves.



White Item # 	Shelf size	Cabinet widths	Cabinet opening	Load capacity	Finish fitting / shelves	Amount of shelves
90098000020	18"	24" x 24"	7-1/4"	33 lbs	1. platinum / white	2
90098000017	24"	27" x 27"	7-1/4"	44 lbs	2. platinum / white	2
90098000022	28"	39" x 39"	13-1/4"	55 lbs	3. platinum / white	2
90098000024	32"	42" x 42"	16-1/4"	66 lbs	4. platinum / white	2

FULLROUND

The VS COR® Susan Fullround includes a set of 2 shelves.

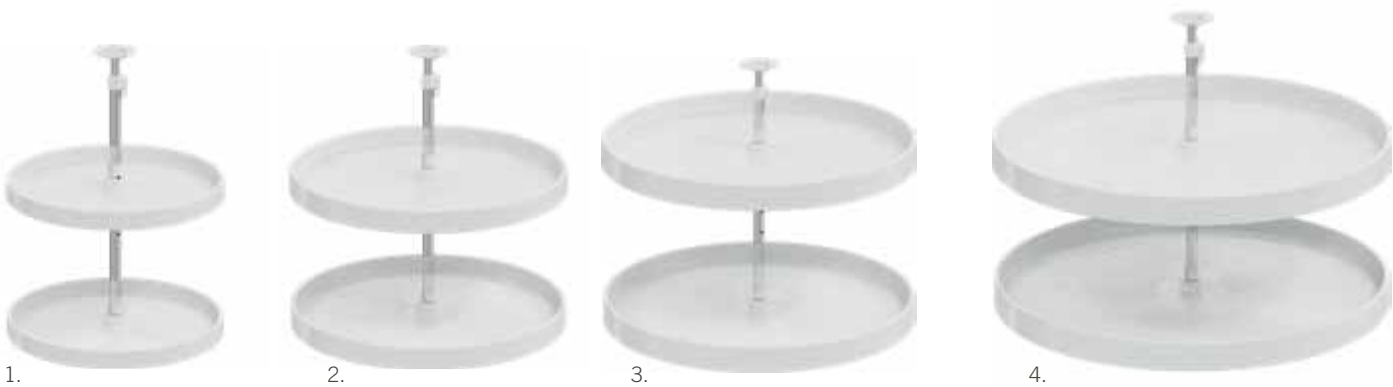

White Item # 	Shelf size	Cabinet widths	Cabinet opening	Load capacity	Finish fitting / shelves	Amount of shelves
90098000009	18"	24" x 24"	9-3/4"	33 lbs	1. platinum / white	2
90098000011	24"	33" x 33"	12-1/4"	44 lbs	2. platinum / white	2
90098000013	28"	36" x 36"	14-3/4"	55 lbs	3. platinum / white	2
90098000015	32"	42" x 42"	16-3/4"	66 lbs	4. platinum / white	2

BULK PACKAGES

KIDNEY

The VS COR® Susan Kidney contains the number of shelves specified below, depending on the size.



White Item #	Shelf size	Cabinet widths	Cabinet opening	Load capacity	Amount of shelves
*	18"	24" x 24"	7-1/4"	33 lbs	
*	24"	27" x 27"	7-1/4"	44 lbs	
*	28"	39" x 39"	13-1/4"	55 lbs	
*	32"	42" x 42"	16-1/4"	66 lbs	

* Item number follows



FULLROUND

The VS COR® Susan Fullround contains the number of shelves specified below, depending on the size.



White Item # 	Shelf size	Cabinet widths	Cabinet opening	Load capacity	Amount of shelves
*	18"	24" x 24"	9-3/4"	33 lbs	2
*	24"	33" x 33"	12-1/4"	44 lbs	2
*	28"	36" x 36"	14-3/4"	55 lbs	2
*	32"	42" x 42"	16-3/4"	66 lbs	2

* Item number follows



WOOD IN ITS MOST
PERFECT FORM.

COMING
SOON

VS COR® Susan Kidney/Fullround Ligano

WOODEN LAZY SUSAN

FEATURES

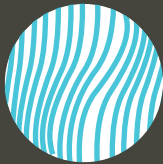

Uniform veneer appearance



Optimal access



Tool-free connection



High load capacity

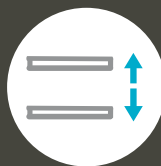

Simple height adjustment,
even when installed



Quality made in Germany
and the US

DETAILS

- **Cabinet widths (CAB):** 33" x 33"
36" x 36"
42" x 42"
- **Installation height:** min. 28"
- **Telescope post height:** 26" to 32"
- **Shelf size:** 24", 28" and 32"

- **Finish:** wood 

KIDNEY LIGANO



The VS COR® Susan Kidney includes a set of 2 shelves



FULLROUND LIGANO

The VS COR® Susan Fullround includes a set of 2 shelves



Platinum / wood Item #	  Shelf size	Cabinet widths	Cabinet opening	Load capacity	Finish Fitting / Trays	Amount of shelves
*	24"	33" x 33"	12-1/4"	44 lbs	1. platinum / wood	2
*	28"	36" x 36"	14-3/4"	55 lbs	2. platinum / wood	2
*	32"	42" x 42"	16-3/4"	66 lbs	3. platinum / wood	2

* Item number follows

SMART REVOLUTION AROUND THE CORNER.

FOR
FACE FRAME
KITCHEN

VS COR® SUSAN PIE CUT PIE CUT DOOR MOUNTED LAZY SUSAN

FEATURES



Ribbed shelf structure gives objects better grip and reduces noise



Assymmetric barrel guide guarantees balanced rotary motion

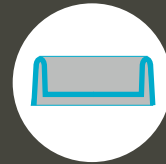

Double layer edge of shelves increases stability



High load capacity

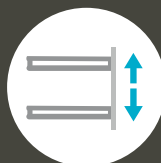

The alignment of the doors can be adjusted manually using the integrated height adjustment in the pole



Retrofit ready can be installed in existing cabinetry without removing the countertop

DETAILS

- **Cabinet widths (CAB):** 33" x 33"
36" x 36"
- **FF Cabinet opening (MCO):** 7-1/4", 10-1/4"
- **Telescope post height:** 26" to 32"
Shelf size: 18", 24" and 28"
- **Load capacity:** 39lbs per shelf
- **Storage version:** Pie Cut polymer shelves

- **Finish:** white 

CABINET DIMENSIONS

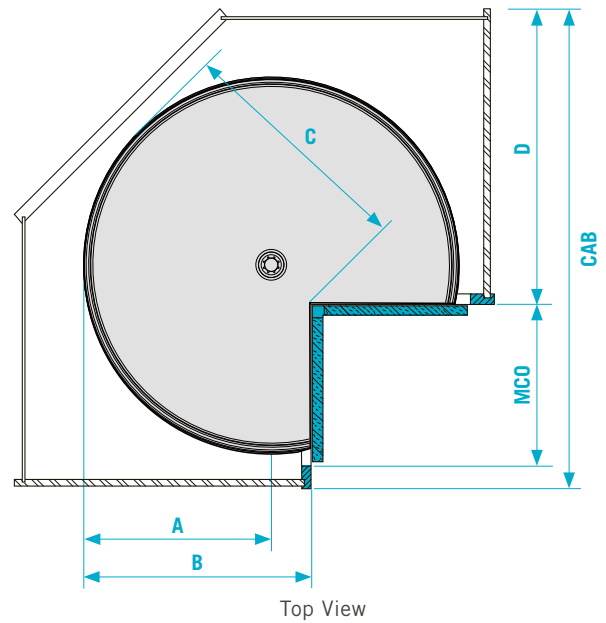

Shelf size	Cabinet widths (CAB)	Cabinet opening (MCO)	Cabinet depth (D)	Installation height	A	B	C
24"	36"	10-1/4"	24"	min. 26"	11-13/16"	13-7/16"	14-1/8"
28"	36"	10-1/4"	24"	min. 26"	13-13/16"	17-3/8"	18-7/8"

* 18" item is available upon request.

VS COR® Susan Pie Cut

The VS COR® Susan Pie Cut comes with a set of 2 shelves.



White 	Shelf size	Cabinet widths	Cabinet opening	Load capacity
90098000026	24"	36" x 36"	10-1/4"	44 lbs per shelf
90098000028	28"	36" x 36"	10-1/4"	55 lbs per shelf

VS

SUB

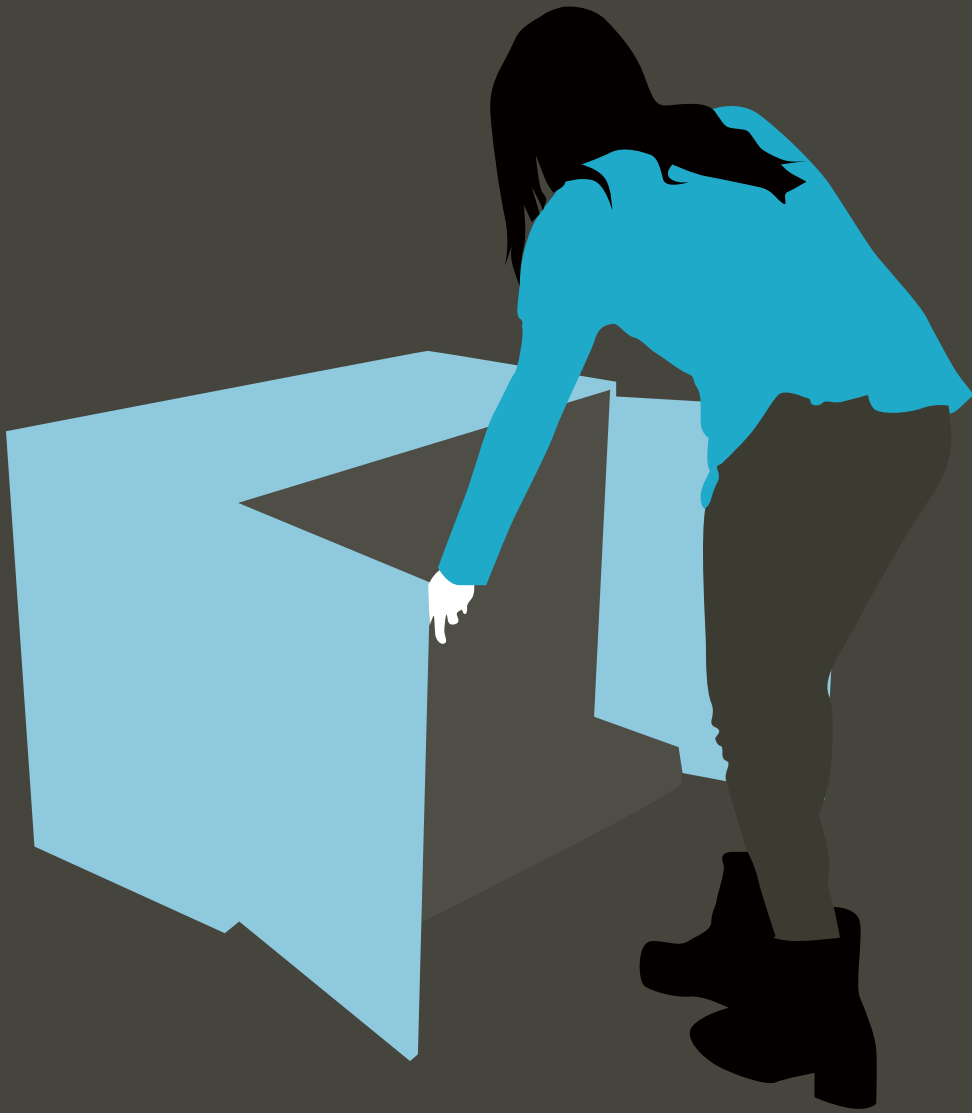

VS SUB[®] — BASE CABINETS

The base cabinet is the foundation of every kitchen. What happens under the work top is as important as what happens on top. Whether food or cooking utensils, cutlery or dishes,

whether for a small student's flat or a trendy loft – our base cabinet solutions are intelligent, versatile and flexible in order to make everyday life easier.

A NEW LOOK FOR THE BASE UNIT SOLUTION.

FOR FACE FRAME & FRAMELESS KITCHEN

VS SUB[®] Side SIDE MOUNTED BASE CABINET PULL-OUT



Watch it!

FEATURES



Optimal use of space

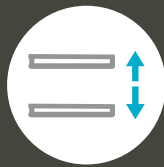

Height-adjustable shelves



Tool-free connection



Two or three set shelf options

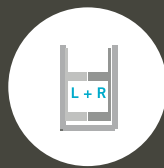

Unhanded installation



3D front Adjustment

DETAILS

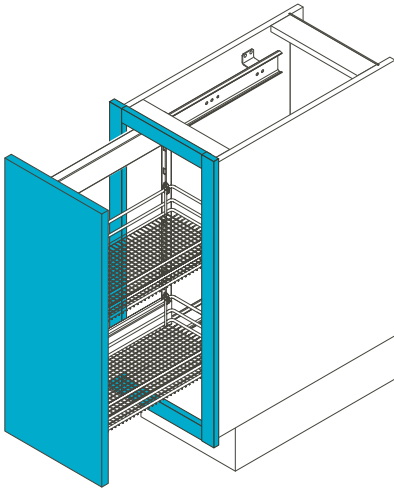

- **Cabinet widths (CAB):**
 - **FF** 9" or 15"
 - **FL** min. 7-1/2" or 13-1/2"
- **Cabinet opening (MCO):**
 - **FF** 6" or 12"
 - **FL** 6" or 12"
- **FF width:** 1-1/2"
- **Installation depth:** 23"
- **Installation height:** min. 20-1/2", 25-1/2" or 30-1/2"
- **Capacity:** 45lbs
- **Storage versions:** Saphir, Scalea and Planero®

- **Finish:**
 - platinum
 - lava
 - platinum maple
 - lava maple
 - lava
 - walnut

CABINET DIMENSIONS

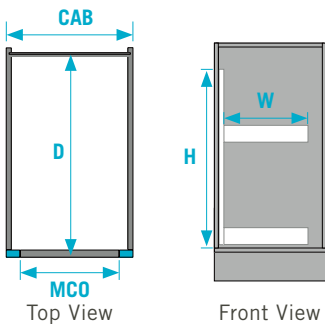

FF

Basket width* (W)	Cabinet widths (CAB)	FF cabinet opening (MCO)	Installation depth (D)	Installation height (H)
4-1/16"	min. 9"	6"	23"	20", 25" or 30-1/2"
10-1/16"	min. 15"	12"	23"	20", 25" or 30-1/2"

*The basket width does not include the frame.

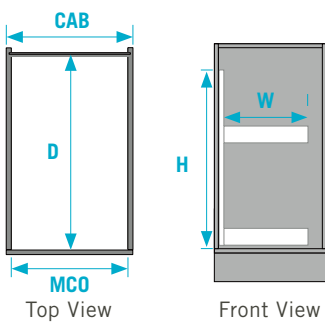

FL

Basket width* (W)	Cabinet widths (CAB)	FL cabinet opening (MCO)	Installation depth (D)	Installation height (H)
4-1/16"	min. 7-1/2"	6"	23"	20", 25" or 30-1/2"
10-1/16"	min. 13-1/2"	12"	23"	20", 25" or 30-1/2"

*The basket width does not include the frame.

SAPHIR

Installation Height 1
min. 20-1/2" (2 baskets)

Cabinet opening 6" Cabinet opening 12"

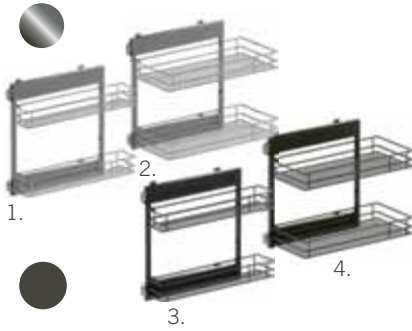

Installation Height 2
min. 25-1/2" (2 or 3 baskets)

Cabinet opening 6" Cabinet opening 12"



Installation Height 3
min. 30-1/2" (2 or 3 baskets)

Cabinet opening 6" Cabinet opening 12"

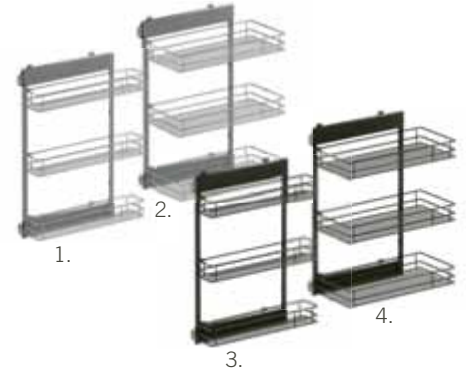

	Installation Height 1 min. 20-1/2" (2 baskets)	Installation Height 2 min. 25-1/2" (2 baskets)	Installation Height 2 min. 25-1/2" (3 baskets)	Installation Height 3 min. 30-1/2" (2 baskets)	Installation Height 3 min. 30-1/2" (3 baskets)
1. Cabinet opening 6"	90092000189	90092000190	90092000192	90092000191	90092000193
2. Cabinet opening 12"	90092000199	90092000200	90092000202	90092000201	90092000203
3. Cabinet opening 6"	90092000129	90092000130	90092000132	90092000131	90092000133
4. Cabinet opening 12"	90092000159	90092000160	90092000162	90092000161	90092000163

SCALEA

Installation Height 1
min. 20-1/2" (2 baskets)

Cabinet opening 6" Cabinet opening 12"

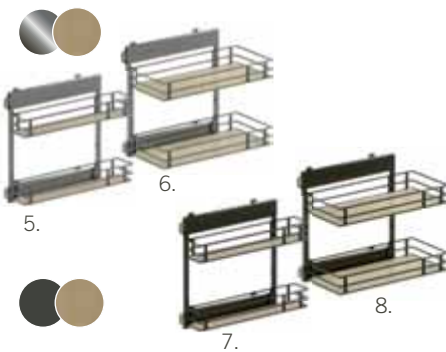

Installation Height 2
min. 25-1/2" (2 baskets)

Cabinet opening 6" Cabinet opening 12"



Installation Height 3
min. 30-1/2" (3 baskets)

Cabinet opening 6" Cabinet opening 12"



	Installation Height 1 min. 20-1/2" (2 baskets)	Installation Height 2 min. 25-1/2" (2 baskets)	Installation Height 2 min. 25-1/2" (3 baskets)	Installation Height 3 min. 30-1/2" (2 baskets)	Installation Height 3 min. 30-1/2" (3 baskets)
5. Cabinet opening 6"	90092000194	90092000195	90092000197	90092000196	90092000198
6. Cabinet opening 12"	90092000204	90092000205	90092000207	90092000206	90092000208
7. Cabinet opening 6"	90092000139	90092000140	90092000142	90092000141	90092000143
8. Cabinet opening 12"	90092000169	90092000170	90092000172	90092000171	90092000173

SCALEA

Installation Height 1 min. 20-1/2" (2 baskets)

Cabinet opening 6" Cabinet opening 12"

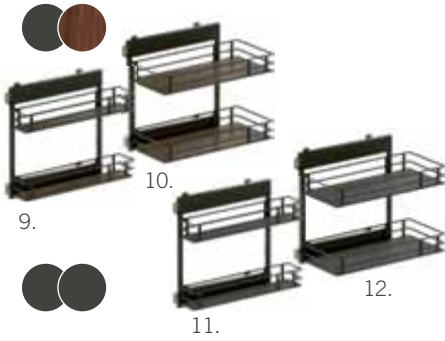

Installation Height 2 min. 25-1/2" (2 or 3 baskets)

Cabinet opening 6" Cabinet opening 12"



Installation Height 3 min. 30-1/2" (2 or 3 baskets)

Cabinet opening 6" Cabinet opening 12"



	Installation Height 1 min. 20-1/2" (2 baskets)	Installation Height 2 min. 25-1/2" (2 baskets)	Installation Height 2 min. 25-1/2" (3 baskets)	Installation Height 3 min. 30-1/2" (2 baskets)	Installation Height 3 min. 30-1/2" (3 baskets)
9. Cabinet opening 6" lava / walnut lava / lava	90092000144	90092000145	90092000147	90092000146	90092000148
10. Cabinet opening 12"	90092000174	90092000175	90092000177	90092000176	90092000178
11. Cabinet opening 6"	90092000134	90092000135	90092000137	90092000136	90092000138
12. Cabinet opening 12"	90092000164	90092000165	90092000167	90092000166	90092000168

PLANERO®

Installation Height 1 min. 20-1/2" (2 trays)

Cabinet opening 6" Cabinet opening 12"



Installation Height 2 min. 25-1/2" (2 trays)

Cabinet opening 6" Cabinet opening 12"



Installation Height 3 min. 30-1/2" (3 trays)

Cabinet opening 6" Cabinet opening 12"

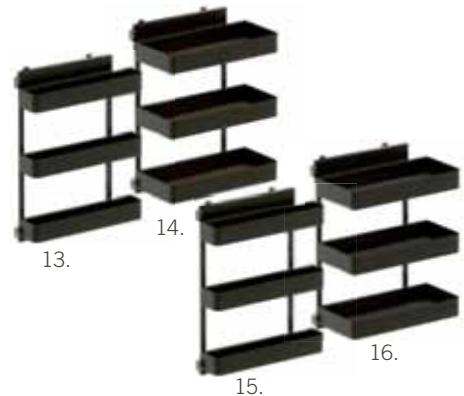

	Installation Height 1 min. 20-1/2" (2 trays)	Installation Height 2 min. 25-1/2" (2 trays)	Installation Height 2 min. 25-1/2" (3 trays)	Installation Height 3 min. 30-1/2" (2 trays)	Installation Height 3 min. 30-1/2" (3 trays)
13. Cabinet opening 6" lava / walnut lava / lava	90092000154	90092000155	90092000157	90092000156	90092000158
14. Cabinet opening 12"	90092000184	90092000185	90092000187	90092000186	90092000188
15. Cabinet opening 6"	90092000149	90092000150	90092000152	90092000151	90092000153
16. Cabinet opening 12"	90092000179	90092000180	90092000182	90092000181	90092000183

NEAT AND TIDY FROM THE BOTTOM UP.

FOR
FACE FRAME &
FRAMELESS
KITCHEN

VS SUB[®] Pantry

BOTTOM MOUNTED BASE CABINET PULL-OUT

FEATURES

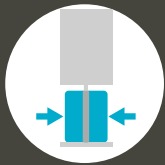

Convenient access

Brings all contents out of the cupboard
Everything can be accessed easily from both sides

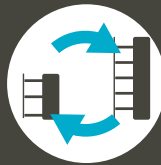

Cross-Use

Shelves can be used interchangeably with the
VS SUB[®] Pantry or the VS TAL[®] Pantry



Easy Fit

Simple frame assembly
on the runners and to the front



Combinable

Compatible with the VS ADD[®] Box
and VS ADD[®] Separator

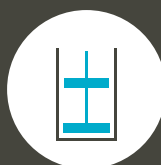

Unhanded Installation

No need to worry about right or left handed
applications, the VS SUB[®] Pantry
works both ways!



3D front Adjustment

Facilitates the convenient and
simple adjustment of the front

DETAILS

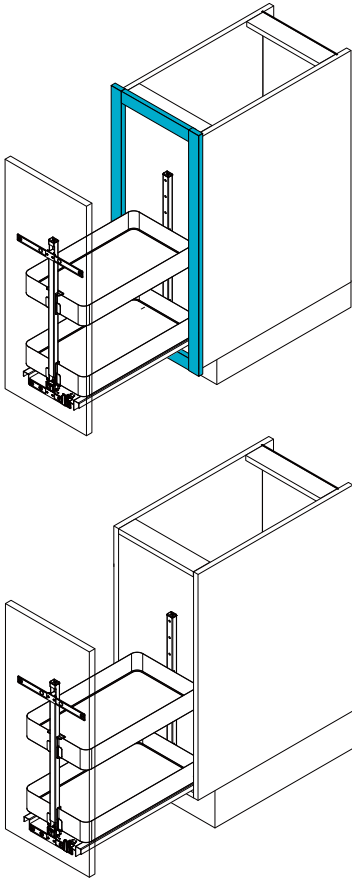

- **Cabinet widths (CAB):**
 - **FF** 12" or 15"
 - **FL** min. 10-1/2" or 13-1/2"
- **Cabinet opening (MCO):**
 - **FF** 9" or 12"
 - **FL** 9" or 12"
- **FF width:** 1-1/2"
- **Installation depth:** min. 22-1/2"
- **Installation height:** min. 26"
- **Capacity:** max. 48.5lbs
- **Storage versions:** Saphir, Scalea Essentio® and Planero®

- **Finish:**
 - platinum ●
 - lava ●
 - white ○

CABINET DIMENSIONS

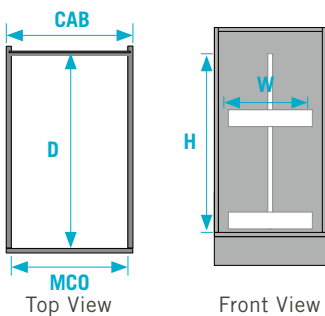
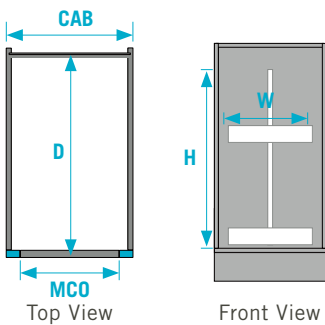

FF

Basket width* (W)	Cabinet widths (CAB)	FF cabinet opening (MCO)	Installation depth (D)	Installation height (H)
8-1/5"	12"	9"	min. 22-1/2"	min. 26"
11-1/2"	15"	12"	min. 22-1/2"	min. 26"

*The basket width does not include the frame.

FL

Basket width* (W)	Cabinet widths (CAB)	FL cabinet opening (MCO)	Installation depth (D)	Installation height (H)
8-1/5"	min. 10-1/2"	9"	min. 22-1/2"	min. 26"
11-1/2"	min. 12-1/2"	12"	min. 22-1/2"	min. 26"

SPACE-SAVING VERSATILITY

With the **VS Pantry® Flex** elements, tall and base cabinets become true space savers. A number of components are available for this purpose.

The basic elements

The storage tray **VS Pantry Flex Tray** in two heights, H0 & H2, serves as a storage board with double-sided access and is designed to integrate the **VS ADD® Boxen**. The boxes are form-fitted and are completed by the back contour to form a unit. The magnetic separating element **VS ADD® Separator** can be used to add additional divisions in the depth. The material, proportions and finishes are perfectly coordinated.

The frame **VS Pantry Flex Frame** fulfils a wide variety of functions. Among other things, it serves as a lateral holder and tip protector above the trays, e.g. for baking trays, chopping boards, step ladders and more. In addition, the frame can be transformed into a flush-mounted tray and be further customised with the insertion of 19-mm-thick standard wood composites.

VS SUB® PANTRY



Fixture VS SUB® Pantry

VS TAL® PANTRY



Fixture VS TAL® Pantry

all shelves and elements are individually interchangeable

VS PANTRY BASKETS & TRAYS

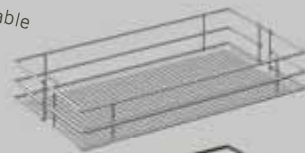

Saphir

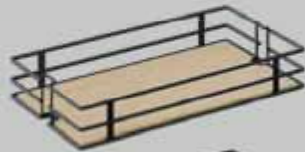
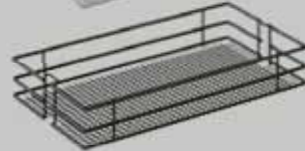

Scalea



Planero®



Additional Flex elements

The hook rail **VS Pantry Flex Hook** – cloths, towels, cooking utensils, or even a dustpan and brush can be hung conveniently from it.

The kitchen roll holder **VS Pantry Flex Roll** – kitchen rolls are optimally integrated with this. Thanks to the intelligent design, paper

towels can be separated straightforwardly without having to remove the roll.

The broom holder **VS Pantry Flex Broom** – It makes the broom simply disappear behind the cupboard door.

VS PANTRY FLEX

EXAMPLE COMBINATION

Basic elements

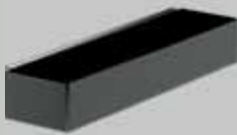

VS Pantry Flex Tray H2



VS Pantry Flex Tray H0



VS Pantry Flex Frame

Additional elements



VS Pantry Flex Hook



VS Pantry Flex Roll



VS Pantry Flex Broom

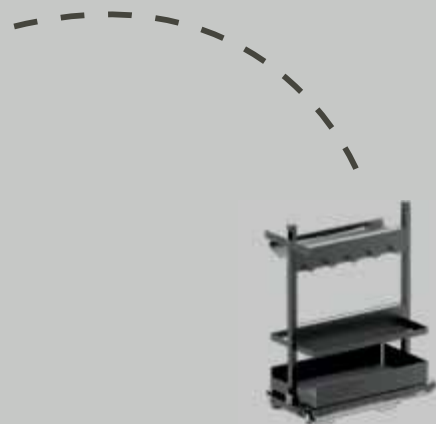

VS SUB® Pantry with VS Pantry Flex



VS TAL® Pantry with VS Pantry Flex

All shelves and VS Pantry Flex elements are compatible with VS TAL® Pantry and VS SUB® Pantry. They cannot be ordered separately.

AN ASTONISHING AMOUNT
OF STORAGE SPACE.

VS Pantry Flex

FLEX TRAYS FOR THE TAL AND SUB PANTRIES

FEATURES

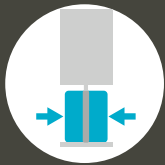

Front and back can be used
in different ways

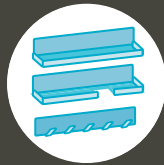

Various trays for different applications

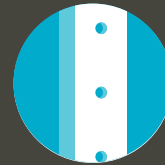

Hole pattern for simple adjustment
to various heights



Compatible with VS SUB® Pantry
and VS TAL® Pantry



For kitchen and utility area,
frame customisable with filling



Modular coordination with
VS ADD® Box and VS ADD® Separator

SETS
VS SUB® PANTRY



VS SUB® Pantry Flex Cook



VS SUB® Pantry Flex Spice



VS SUB® Pantry Flex Bake



VS SUB® Pantry Flex Clean



VS SUB® Pantry Flex Free

WOOD AT THE HEART OF AMERICAN KITCHES.

FOR FACE FRAME KITCHEN

VS SUB[®] Rack Ligano BOTTOM MOUNTED BASE CABINET PULL-OUT

FEATURES

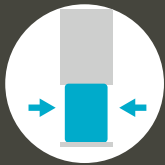

Convenient access
Brings all contents out of the cupboard.
Everything can be accessed easily from both sides

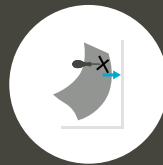

Installation template for easy and fast installation



Easy Fit
Simple frame assembly on the runners and to the front



Combinable
Compatible with the VS ADD[®] Box



Unhanded Installation
No need to worry about right or left handed applications, the VS SUB[®] Rack Ligano works both ways!



3D front Adjustment
Facilitates the convenient and simple adjustment of the front

DETAILS

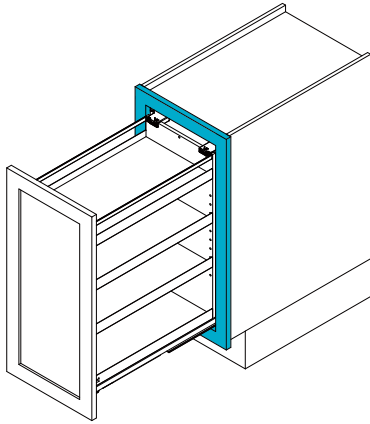

- **Cabinet widths (CAB):**
FF 9", 12", 15" or 18"
- **Cabinet opening (MCO):**
 6", 9", 12" or 15"
- **FF width:**
 1-1/2"
- **Installation depth:**
 min. 22-1/2"
- **Installation height:**
 min. 26-1/2"
- **Capacity:**
 max. 44lbs

- **Finish:**
 - platinum wood 

 - lava wood 

CABINET DIMENSIONS

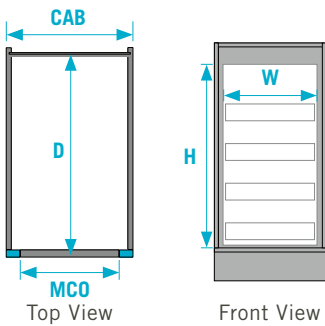

Fitting width* (W)	Cabinet widths (CAB)	FF cabinet opening (MCO)	Installation depth (D)	Installation height (H)
6-9/16"	9"	6"	min. 22-1/2"	min. 26-1/2"
9-9/16"	12"	9"	min. 22-1/2"	min. 26-1/2"
12-9/16"	15"	12"	min. 22-1/2"	min. 26-1/2"
15-9/16"	18"	15"	min. 22-1/2"	min. 26-1/2"

*Including the front attachment.

VS SUB® RACK LIGANO Preassembled

- Bottom mounted
- Pullouts with soft-close

COMING
SOON

MARKET
INNOVATION:
STABILIZER ROLLERS
COMPLETELY PREVENT
WOBBLING

Cabinet opening
6"



Cabinet opening
9"



VS SUB® RACK LIGANO
Preassembled

- Bottom mounted
- Pullouts with soft-close

Cabinet opening
12"



Cabinet opening
15"



* Item numbers follow

VS
TAL



VS TAL® – TALL CABINETS

An elegant tall cabinet is the key to a happy kitchen. As a storage cabinet for food or as a practical storage option for kitchen utensils, it significantly contributes to improved working

efficiency and an increased quality of life. Neither narrow gaps nor small opening angles stand in the way of our tal cabinet solutions.

FOR
FACE FRAME &
FRAMELESS
KITCHEN

YOUR STOCKPILE OF
ACCESSIBLE
STORAGE SPACE.

VS TAL[®] Pantry

TOP AND BOTTOM MOUNTED TALL CABINET PULL-OUT



Watch it!

FEATURES



PAM: Optional
Power-Assisted Movement



Synchronised upper and
lower end stops

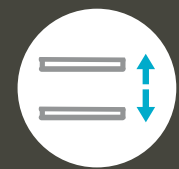

Height adjustable shelves



Save time by having complete
visibility with one pull



Heavy-duty noise-restricting
roller slides

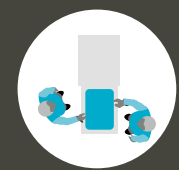

Optimal access

DETAILS

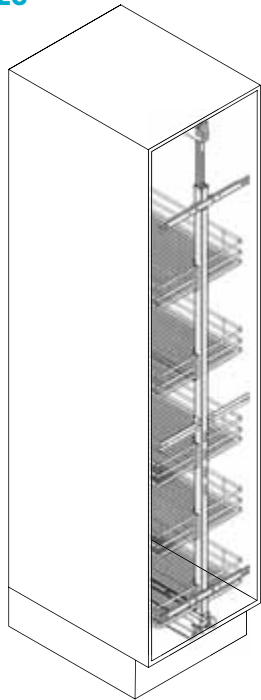

• **Cabinet widths (CAB):**

FF

12", 15", 18", 21", 24"

FL

10.5", 13.5", 16.5", 19.5", 22.5"

• **Cabinet opening (MCO):**

9", 12", 15", 18" and 21"

• **Installation height:**

37-1/2" to 84-1/4"

• **Installation depth:**

22-1/2"

• **Load capacity:**

max. 176lbs

• **Storage versions:**

Saphir, Scalea and Planero®

• **Finish:**

platinum		lava	
platinum		lava	
maple		maple	
lava			
walnut			

• **Additionally available:**

Opening Support PAM

CABINET DIMENSIONS

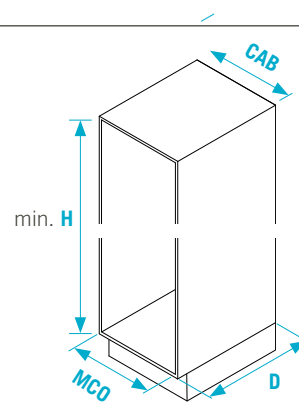

FF cabinet widths (CAB)	FL cabinet widths (CAB)	Cabinet opening (MCO)	Installation depth (D)	Installation height 1 (H)	Installation height 2 (H)	Installation height 3 (H)	Installation height 4 (H)	Installation height 5 (H)
12"	min. 10-1/2"	9"	22-1/2"	37-1/2"	47-1/4"	57"	67"	76-3/4"
15"	min. 13-1/2"	12"	22-1/2"	37-1/2"	47-1/4"	57"	67"	76-3/4"
18"	min. 16-1/2"	15"	22-1/2"	37-1/2"	47-1/4"	57"	67"	76-3/4"
21"	min. 19-1/2"	18"	22-1/2"	37-1/2"	47-1/4"	57"	67"	76-3/4"
24"	min. 22-1/2"	21"	22-1/2"	37-1/2"	47-1/4"	57"	67"	76-3/4"

FIND OUT THE RIGHT SIZE YOU NEED

The **frame** comes in 5 different heights. Each frame is **telescopic**. Identify your cabinet size and whether you want to have a Silver or Lava frame. Choose your **basket design** and preferred **color version**. Your chosen frame height defines the recommended amount of baskets, the internal cabinet width defines the width of the baskets.

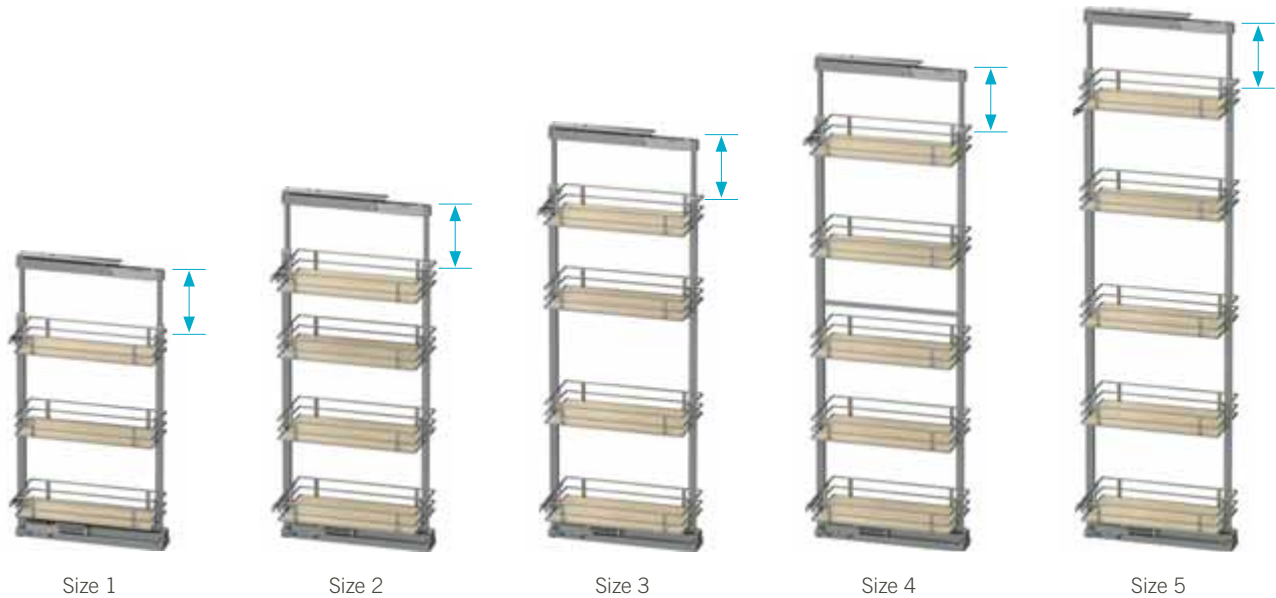

Size	Cab. opening height	Height adjustable	Recommended amount of baskets
1	37-1/2"-47-1/4"	10"	3
2	47-1/4"-57"	10"	4
3	57"-67"	10"	4
4	67"-76-3/4"	10"	5
5	76-3/4"-84-1/4"	10"	5



Saphir Platinum

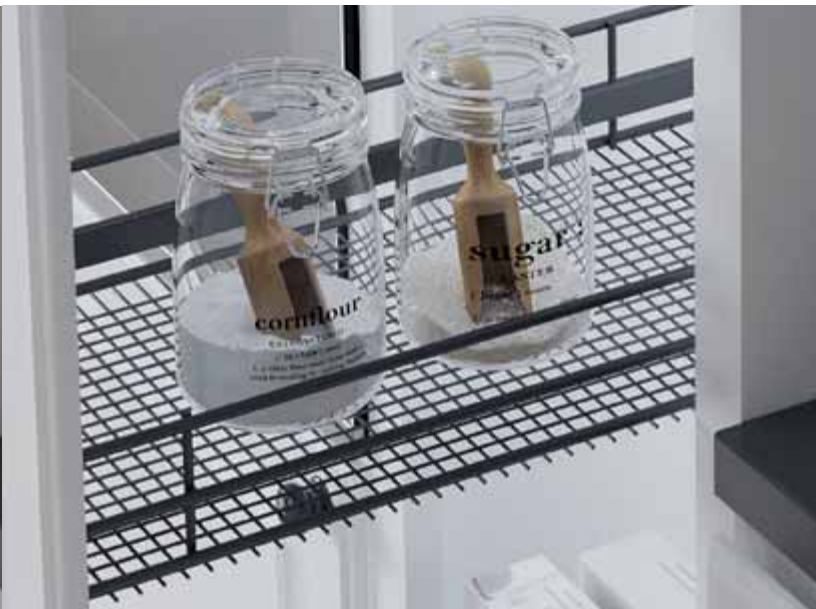

Saphir Lava



Scalea Lava / Maple



Scalea Lava / Lava



Planero® Lava Maple



Planero® Lava / Lava

SAPHIR

Cabinet Opening Height
37-1/2"-47-1/4"

Cabinet Opening Height
47-1/4"-57"

Cabinet Opening Height
57"-67"

Cabinet Opening Height
67"-76-3/4"

Cabinet Opening Height
76-3/4"-84-1/4"

Fitting: silver Baskets: platinum



Cabinet width	1. Cabinet opening height 1 (3 baskets)	2. Cabinet opening height 2 (4 baskets)	3. Cabinet opening height 3 (4 baskets)	4. Cabinet opening height 4 (5 baskets)	5. Cabinet opening height 5 (5 baskets)
12"	90092000329	90092000339	90092000349	90092000359	*
15"	90092000331	90092000341	90092000351	90092000361	*
18"	90092000333	90092000343	90092000353	90092000363	*
21"	90092000335	90092000345	90092000355	90092000365	*
24"	90092000337	90092000347	90092000357	90092000367	*

Fitting and Baskets: lava



Cabinet width	1. Cabinet opening height 1 (3 baskets)	2. Cabinet opening height 2 (4 baskets)	3. Cabinet opening height 3 (4 baskets)	4. Cabinet opening height 4 (5 baskets)	5. Cabinet opening height 5 (5 baskets)
12"	90092000209	90092000239	90092000269	90092000299	*
15"	90092000215	90092000245	90092000275	90092000305	*
18"	90092000221	90092000251	90092000281	90092000312	*
21"	90092000227	90092000257	90092000287	90092000317	*
24"	90092000233	90092000263	90092000293	90092000323	*

* Item number follows

SCALEA

Cabinet Opening Height
37-1/2"-47-1/4"

Cabinet Opening Height
47-1/4"-57"

Cabinet Opening Height
57"-67"

Cabinet Opening Height
67"-76-3/4"

Cabinet Opening Height
76-3/4"-84-1/4"

Fitting: silver Baskets: platinum / maple



Cabinet width	1. Cabinet opening height 1 (3 baskets)	2. Cabinet opening height 2 (4 baskets)	3. Cabinet opening height 3 (4 baskets)	4. Cabinet opening height 4 (5 baskets)	5. Cabinet opening height 5 (5 baskets)
---------------	---	---	---	---	---

12"	90092000330	90092000340	90092000350	90092000360	*
15"	90092000332	90092000342	90092000352	90092000362	*
18"	90092000334	90092000344	90092000354	90092000364	*
21"	90092000336	90092000346	90092000356	90092000366	*
24"	90092000338	90092000348	90092000358	90092000368	*

Fitting: lava Baskets: lava / maple



Cabinet width	1. Cabinet opening height 1 (3 baskets)	2. Cabinet opening height 2 (4 baskets)	3. Cabinet opening height 3 (4 baskets)	4. Cabinet opening height 4 (5 baskets)	5. Cabinet opening height 5 (5 baskets)
---------------	---	---	---	---	---

12"	90092000211	90092000241	90092000271	90092000301	*
15"	90092000217	90092000247	90092000277	90092000307	*
18"	90092000223	90092000253	90092000283	90092000313	*
21"	90092000229	90092000259	90092000289	90092000319	*
24"	90092000235	90092000265	90092000295	90092000325	*

* Item number follows

SCALEA

Cabinet Opening Height
37-1/2"-47-1/4"

Cabinet Opening Height
47-1/4"-57"

Cabinet Opening Height
57"-67"

Cabinet Opening Height
67"-76-3/4"

Cabinet Opening Height
76-3/4"-84-1/4"

Fitting: lava Baskets: lava / walnut



Cabinet width

1. Cabinet opening height 1
(3 baskets)

2. Cabinet opening height 2
(4 baskets)

3. Cabinet opening height 3
(4 baskets)

4. Cabinet opening height 4
(5 baskets)

5. Cabinet opening height 5
(5 baskets)

12"

90092000212

90092000242

90092000272

90092000302

*

15"

90092000218

90092000248

90092000278

90092000308

*

18"

90092000224

90092000254

90092000284

90092000314

*

21"

90092000230

90092000260

90092000290

90092000320

*

24"

90092000236

90092000266

90092000296

90092000326

*

Fitting and Baskets: lava



Cabinet width

1. Cabinet opening height 1
(3 baskets)

2. Cabinet opening height 2
(4 baskets)

3. Cabinet opening height 3
(4 baskets)

4. Cabinet opening height 4
(5 baskets)

5. Cabinet opening height 5
(5 baskets)

12"

90092000210

90092000240

90092000270

90092000300

*

15"

90092000216

90092000246

90092000276

90092000306

*

18"

90092000222

90092000252

90092000282

90092000312

*

21"

90092000228

90092000258

90092000288

90092000318

*

24"

90092000234

90092000264

90092000294

90092000324

*

* Item number follows

PLANERO®

Cabinet Opening Height
37-1/2"-47-1/4"

Cabinet Opening Height
47-1/4"-57"

Cabinet Opening Height
57"-67"

Cabinet Opening Height
67"-76-3/4"

Cabinet Opening Height
76-3/4"-84-1/4"

Fitting: lava Trays: lava / walnut



Cabinet width	1. Cabinet opening height 1 (3 trays)	2. Cabinet opening height 2 (4 trays)	3. Cabinet opening height 3 (4 trays)	4. Cabinet opening height 4 (5 trays)	5. Cabinet opening height 5 (5 trays)
---------------	---------------------------------------	---------------------------------------	---------------------------------------	---------------------------------------	---------------------------------------

12"	90092000214	90092000244	90092000274	90092000304	*
15"	90092000220	90092000250	90092000280	90092000310	*
18"	90092000226	90092000256	90092000286	90092000316	*
21"	90092000232	90092000262	90092000292	90092000322	*
24"	90092000238	90092000268	90092000298	90092000328	*

Fitting: lava Trays: lava / lava



Cabinet width	1. Cabinet opening height 1 (3 trays)	2. Cabinet opening height 2 (4 trays)	3. Cabinet opening height 3 (4 trays)	4. Cabinet opening height 4 (5 trays)	5. Cabinet opening height 5 (5 trays)
---------------	---------------------------------------	---------------------------------------	---------------------------------------	---------------------------------------	---------------------------------------

12"	90092000213	90092000243	90092000273	90092000303	*
15"	90092000219	90092000249	90092000279	90092000309	*
18"	90092000225	90092000255	90092000285	90092000315	*
21"	90092000231	90092000261	90092000291	90092000321	*
24"	90092000237	90092000267	90092000297	90092000327	*

* Item number follows

VS Pantry Flex

FLEX TRAYS FOR THE TAL PANTRY

FEATURES

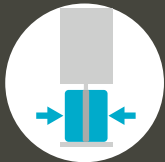

Front and back can be used
in different ways

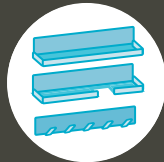

Various trays for different applications



Hole pattern for simple adjustment
to various heights



Compatible with VS SUB® Pantry
and VS TAL® Pantry



For kitchen and utility area,
frame customisable with filling



Modular coordination with
VS ADD® Box and VS ADD® Separator

SETS
VS SUB® PANTRY



Pantry Flex Broom



Pantry Flex Wash



Pantry Flex Tool



Pantry Flex Iron

VS
TOP



VS TOP® – WALL CABINETS

Taking advantage of every possible space – that is the highest imperative in the development of our top cabinet solutions. It makes no difference whether it's full-fledged storage for dishes or a well-arranged

spice container shelf. Organization and optimal use of space support everyday work in the kitchen and make space for the beautiful things in life.

SMALL COMPONENTS WITH A HUGE BENEFIT.

THE PERFECT
FIT FOR YOUR
CABINET



VS TOP® Hang 26 CABINET / CLOSET HANGER

FEATURES



3D adjustment



Up to 229 lbs per set load capacity



Made completely of steel and anti-corrosion zinc coating



Automated installation possible





For steel rail, hook and wood rail suspension with hooks



LGA-certificated high-end quality

DETAILS VS TOP® Hang 26

- Load capacity of up to 229 lbs per wall cabinet as per DIN EN 15939
- Made completely of steel
- Bearing arm open
- Suitable for very heavy loads
- Visible installation with low space requirements
- For steel rail
- Quick and precise adjustment using a cross-head screwdriver Pozidriv PZ2
- Automated installation possible

- **Surface finish:** nickel 
- white 

DIMENSIONS

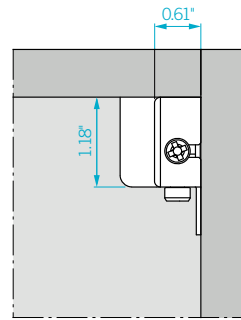

Space requirement in the carcass

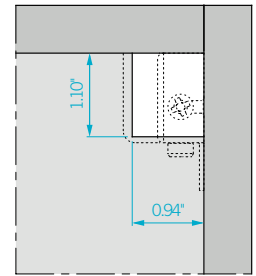

Back wall cutout

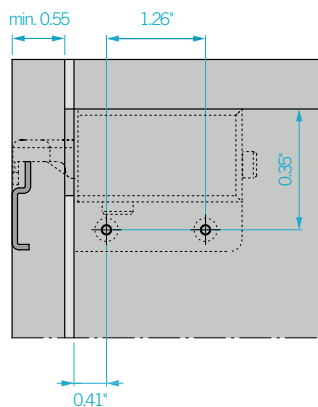

Mounting with suspension rail

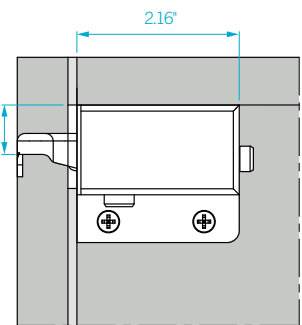

Space requirement on the side wall





white 	nickel 	Installation side
10048259233	10048261223	Left
10048260233	10048264223	Right

OPTIONAL: ADD A SUSPENSION RAIL AND COVER

Also suitable for the VS TOP® Hang 40



Zinc 	Rail length	Material	Surface	HTS Code
90055000003	93"	Metal	Zinc	83024200

Cover 	Material
90055000004	Plastic

SMALL COMPONENTS WITH A HUGE BENEFIT.

THE PERFECT
FIT FOR YOUR
CABINET

VS TOP® Hang 40 CABINET / CLOSET HANGER

FEATURES



3D adjustment



Up to 202 lbs per set load capacity



Cover caps available in different colors and silver metalized



Automated installation possible



Made in Germany







LGA-certificated high-end quality

DETAILS

- Load capacity of up to 202 lbs per set as per DIN EN 15939
- Made completely of steel, anti-corrosion zinc coating
- Bearing arm open
- Suitable for very heavy loads
- Visible installation with low space requirements
- For steel rail hook and wood rail suspension with hooks
- Screw fixing prevents accidental unscrewing
- Automated installation possible

- Finish color caps:

white		pearlwhite / almond	
gray		brown	
black			

DIMENSIONS

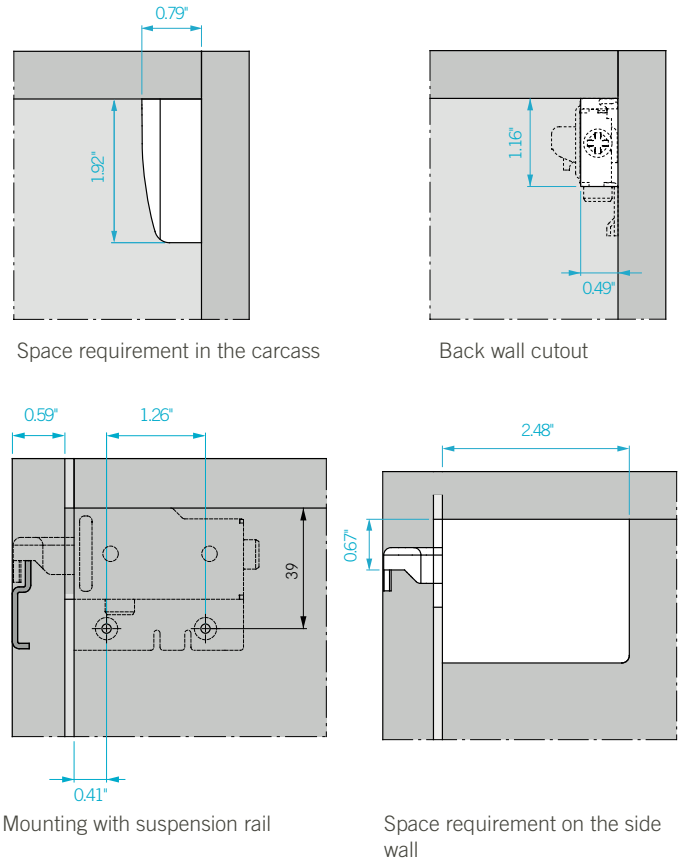

STEP 1: CHOOSE A VS TOP® Hang 40



Steel 	Installation Side
10045067233	Left
10045068233	Right

STEP 2: CHOOSE A VS TOP® Hang 40 COVER CAP



10045038133	10045062133	10045077133	10045060133	10045061133	Left
10045039133	10045066133	10045078133	10045064133	10045065133	Right



VS
ADD



VS ADD[®] - ACCESSORIES

It's often the small things that make our lives more beautiful. Our add-on solutions are the best example of this. They provide more organization and convenience at home and complete

the kitchen, turning it into a modern, cross-generational living space. After all, everyone should feel comfortable there, down to the last detail.



EVERYTHING ON BOARD.
ANYWHERE.



VS ADD® Board

VERSATILE, CUSTOMISABLE WALL SHELF

FEATURES



Additional storage space made of high quality powder-coated, bevelled sheet steel



Combinable
Can be combined with the VS ADD® Box and VS ADD® Separator



Universal use
for the kitchen, bathroom, utility room or lounge



Raised front edge to prevent boxed and stored items from slipping



Easy installation
Simple, invisible wall mounting

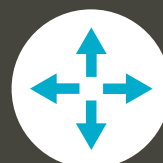

2D adjustment + locking mechanism
Simple, invisible fixing with 2D adjustment system and locking mechanism

DETAILS

VS ADD® Board-3

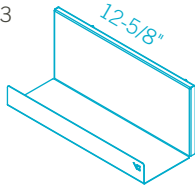

VS ADD® Board-5

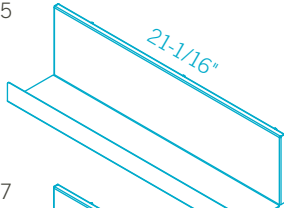

VS ADD® Board-7

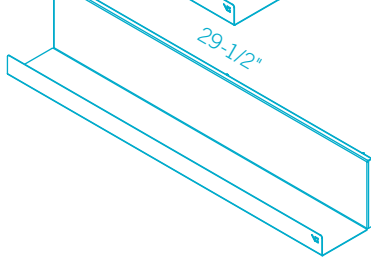

• **Product dimensions:**

VS ADD® Board 3:

5-9/16" (H) x 12-5/8" (W) x 4-3/4" (D)

VS ADD® Board 5:

5-9/16" (H) x 21-1/16" (W) x 4-3/4" (D)

VS ADD® Board 7:

5-9/16" (H) x 29-1/2" (W) x 4-3/4" (D)

• **Capacities:**

11 lbs

15.5 lbs

19.8 lbs

• **Finish:**

Silk matt

white



silver



lava



Matt structure

aluST*



stoneST*



neroST*



SINGLE BOARDS

1. white



2. silver



3.lava



4. aluST*



5. stoneST*



6. neroST*



Board

10090009712

10090009716

10090009715

10090009713

10090009714

10090009717

VS ADD® Board-3

10090009724

10090009727

10090009728

10090009725

10090009726

10090009729

VS ADD® Board-5

10090009736

10090009739

10090009740

10090009737

10090009738

10090009741

VS ADD® Board-7

VS ADD® Board SETS

VS ADD® Board-3 Box-M Set



Consists of:

1 x ADD® Board-3

1 x ADD® Box M3 1x1

1 x ADD® Box M2 1x1

VS ADD® Board-5 Box-M Set



Consists of:

1 x ADD® Board-5

1 x ADD® Box M3 2x1

1 x ADD® Box M2 2x1

VS ADD® Board-7 Box-M Set



Consists of:

1 x ADD® Board-7

1 x ADD® Box M3 2x1

1 x ADD® Box M3 1x1

1 x ADD® Box M2 2x1

1 x ADD® Box M2 1x1

1. white



2. silver



3. lava



4. aluST*



5. stoneST*



6. neroST*



Board width

10090009718

10090009722

10090009721

10090009719

10090009720

10090009723

VS ADD® Board-3

10090009730

10090009733

10090009734

10090009731

10090009732

10090009735

VS ADD® Board-5

10090009742

10090009745

10090009746

10090009743

10090009744

10090009747

VS ADD® Board-7

* stoneST, aluST and neroST are available upon request from Germany.

BEAUTIFULLY TIDY, INSIDE AND OUT



VS ADD[®] Box

Watch it!

METAL OR PLASTIC BOXES FOR ORGANISING THE INTERIOR

FEATURES



Easy to clean metal boxes
with open corners for ease of cleaning



Compatible
Design complements the Planero[®]
and Essentio[®] range



Universal use
for the kitchen, bathroom,
utility room or lounge



Plastic boxes and lids are
dishwasher-safe



Metal boxes have rubber pads: for non-slip,
noise reduction and to prevent scratches



Plastic lids and boxes have
an antimicrobial finish

DETAILS

• **Product dimensions and volumes:**

VS ADD Box is available in 4 different sizes as a metal (M) or plastic version (P).

• **Metal**

VS ADD® Box M2 1x1: 4-5/32" (W) x 2-3/4" (H) x 4-5/32" (D)

VS ADD® Box M2 2x1: 8-3/8" (W) x 2-3/4" (H) x 4-5/32" (D)

VS ADD® Box M3 1x1: 4-5/32" (W) x 5-1/2" (H) x 4-5/32" (D)

VS ADD® Box M3 2x1: 8-3/8" (W) x 5-1/2" (H) x 4-5/32" (D)

• **Plastic**

VS ADD® Box P2 1x1: 4-5/32" (W) x 2-3/4" (H) x 4-5/32" (D); volume 0,6l

VS ADD® Box P2 2x1: 8-3/8" (W) x 2-3/4" (H) x 4-5/32" (D); volume 1,3l

VS ADD® Box P3 1x1: 4-5/32" (W) x 5-1/2" (H) x 4-5/32" (D); volume 1,3l

VS ADD® Box P3 2x1: 8-3/8" (W) x 5-1/2" (H) x 4-5/32" (D); volume 2,7l

• **Finish: Silk matt**

white



silver



lava



Matt structure

aluST*



stoneST*



neroST*



BOXES METAL

PRODUCT MEASUREMENTS

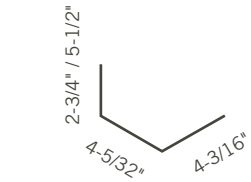

VS ADD® Box M2 1x1

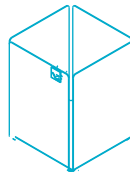

VS ADD® Box M3 1x1

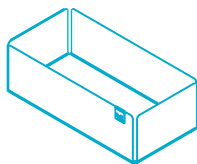
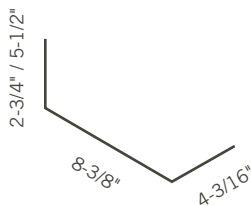

VS ADD® Box M2 2x1

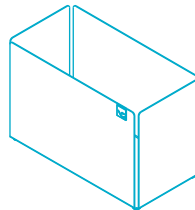

VS ADD® Box M3 2x1

LIDS



VS ADD® Box M Lid 1x1



VS ADD® Box M Lid-hole 1x1

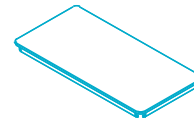

VS ADD® Box M Lid 2x1

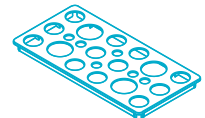

VS ADD® Box M Lid-hole 2x1

BOXES PLASTIC

PRODUCT MEASUREMENTS

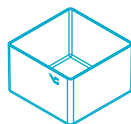
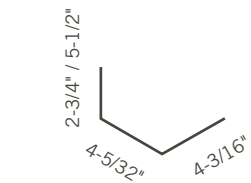

VS ADD® Box P2 1x1

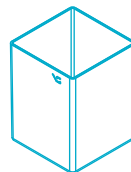

VS ADD® Box P3 1x1

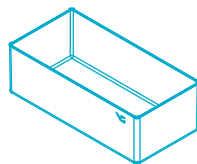
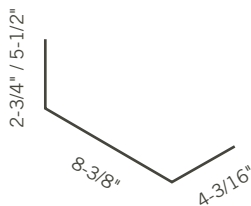

VS ADD® Box P2 2x1

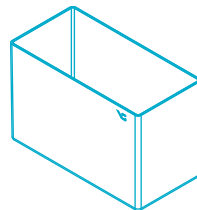

VS ADD® Box P3 2x1

LIDS



VS ADD® Box P Lid 1x1



VS ADD® Box P Lid-hole 1x1

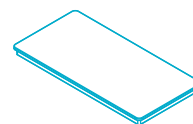

VS ADD® Box P Lid 2x1

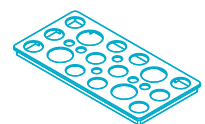





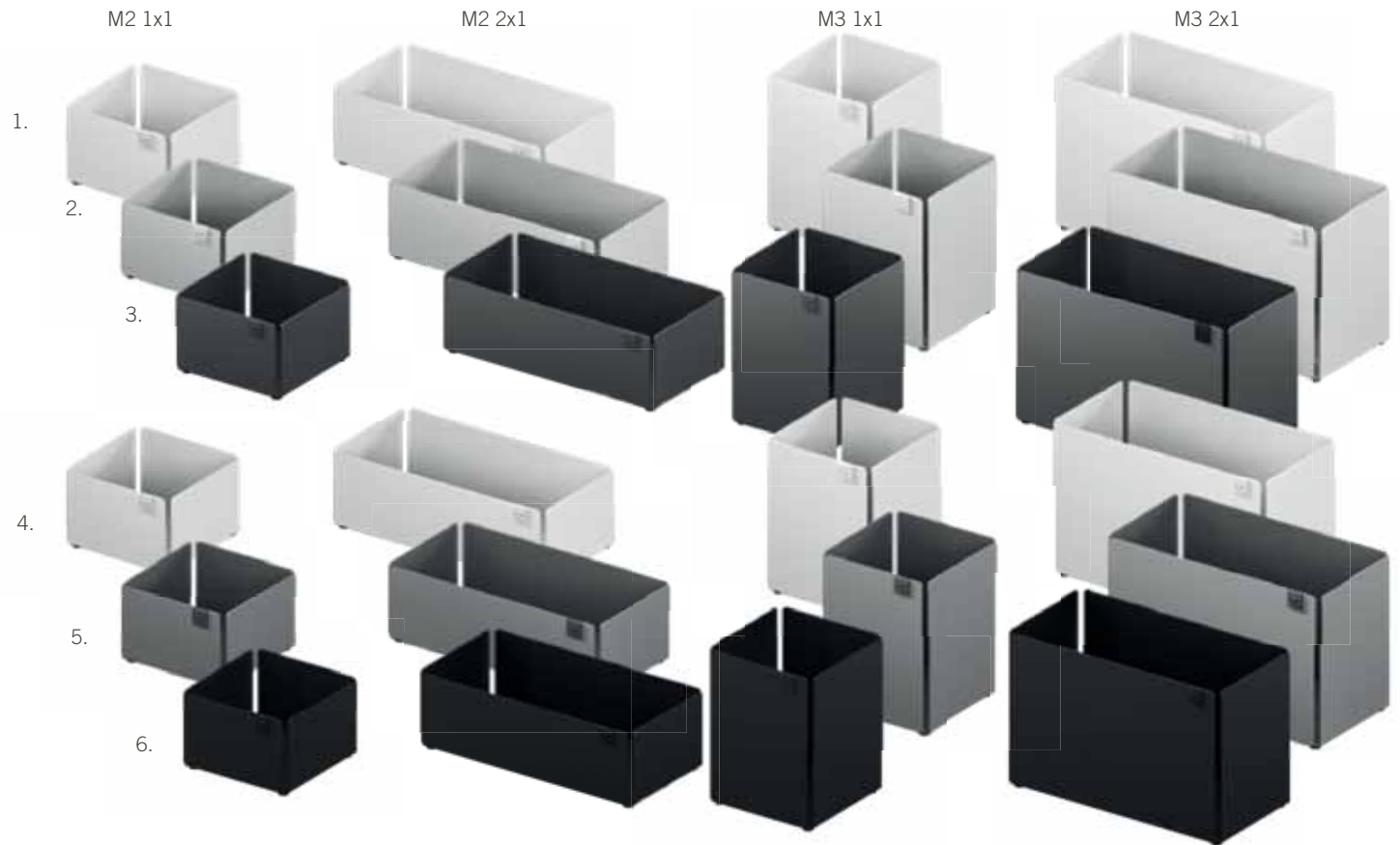

VS ADD® Box P Lid-hole 2x1

* stoneST, aluST and neroST are available upon request from Germany.

METAL BOXES



1. white  2. silver  3. lava  4. aluST*  5. stoneST*  6. neroST*  Box

10090009688	10090009690	10090009692	10090009689	10090009691	10090009693	M2 1x1
10090009694	10090009696	10090009698	10090009695	10090009697	10090009699	M2 2x1
10090009700	10090009702	10090009704	10090009701	10090009703	10090009705	M3 1x1
10090009706	10090009708	10090009710	10090009707	10090009709	10090009711	M3 2x1

* aluST, stoneST and neroST are available upon request from Germany.

PLASTIC LIDS FOR METAL BOXES

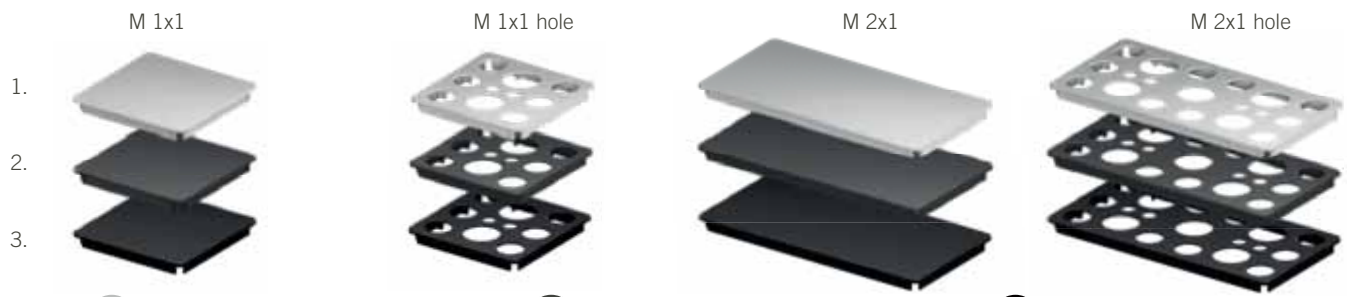

1. gray  2. lava  3. neroST*  Lid

10090009676	10090009677	10090009678	M 1x1
10090009682	10090009683	10090009684	M 2x1
10090009679	10090009680	10090009681	M 1x1 hole
10090009685	10090009686	10090009687	M 2x1 hole

* neroST is available upon request from Germany.

PLASTIC BOXES

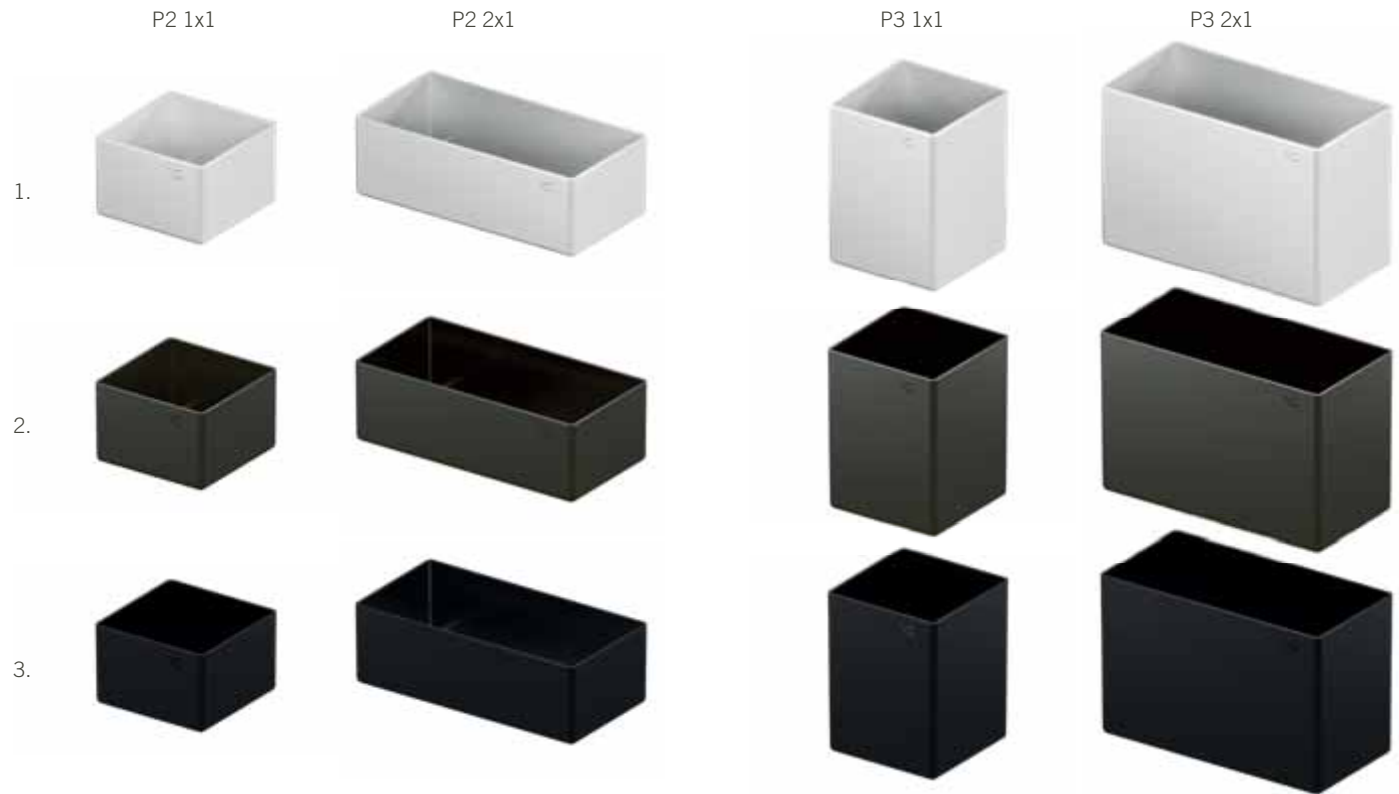

1. white 

2. lava 

3. neroST* 

Box

10090009654	10090009652	10090009653	P2 1x1
10090009657	10090009655	10090009656	P2 2x1
10090009660	10090009658	10090009659	P3 1x1
10090009663	10090009661	10090009662	P3 2x1

* neroST is available upon request from Germany.

PLASTIC LIDS FOR PLASTIC BOXES



1. gray 

2. lava 

3. neroST* 

Lid

10090009668	10090009667	10090009669	P 1x1
10090009671	10090009670	10090009672	P 2x1
10090009665	10090009664	10090009666	P 1x1 hole
10090009674	10090009673	10090009675	P 2x1 hole

* neroST is available upon request from Germany.

PERFECTLY POSITIONED
FOR ORGANISED
INTERIORS.



VS ADD[®] Separator

A MAGNET FOR ORDER



Watch it!

FEATURES



Universal use
for the kitchen, bathroom,
utility room or lounge



Stick without scratching thanks to
rubber pads.



Perfect for organised storage inside the
VS sheet-steel ranges Planero[®] and
Essentio[®]: same materials, proportions and
finishes.



Compatible with the Essentio[®] and
Planero[®] shelf stop.



For flexible use without the need for
drilled holes: two integrated magnets allow the
boxes to be fixed to metallic surfaces

DETAILS

- Product dimensions:**

2-3/4" (H)

1-3/32" (W)

2-15/16" (D)

- Finish:**

Silk matt

white



silver



lava



Matt structure

aluST*



stoneST*



neroST*

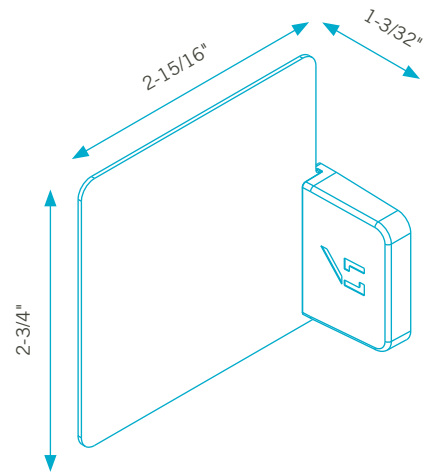

1. white



2. silver



3. lava



4. aluST*



5. stoneST*



6. neroST*



10090009750

10090009752

10090009751

10090009748

10090009749

10090009753

* aluST, stoneST and neroST are available upon request from Germany.

AN EASY WAY,
FOR EVERY DAY.



VS ADD[®] Iron
PULL-OUT IRONING BOARD

FEATURES

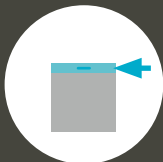

Extendable ironing board
for mounting behind a drawer front



The ironing board is pulled out in front of the cabinet on a telescopic guide and pivots automatically to a comfortable working height

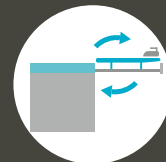

Optimal use of space



High quality stable, solid construction



Can be installed in existing cabinetry

DETAILS

- **Cabinet widths (CAB):** 15-3/4" to 16-11/16"
- **Installation depth:** min. 20"
- **Installation height:** min. 4-3/4"
- **Ironing board dimensions:** 37-13/32" x 11-13/16"

- **Finish:** white

FOR
FRAMELESS
KITCHEN

FL

min. 4-3/4"

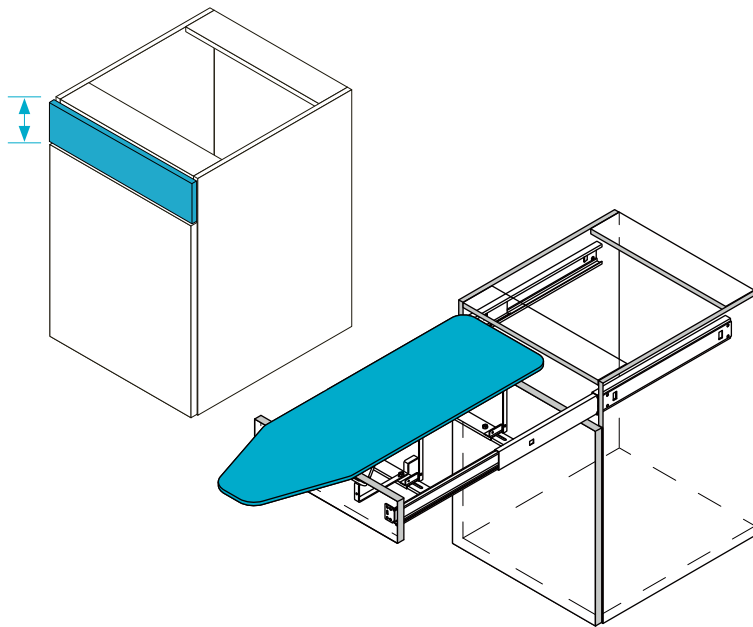

white

10090000120

VS
WASH





VS WASH®

The VS WASH® is the neat solution for dirty laundry. With our laundry system, dirty laundry can finally be sorted, stored and transported not only neatly, but also completely out of sight.

The concealed drop is perfectly integrated into any utility room. Technically and visually, VS WASH® is based on the proven waste separation systems of the VS ENVI® range, creating a uniform look

for both recycling and laundry solutions. The new laundry hampers in a unique variety of types are perforated to ensure optimal air circulation. The perforations are even rounded on the container interior, making a unique contribution to the gentle handling of the laundry. Thanks to the handle, the way to the washing machine is easier than ever before – even with two laundry hampers at once.

FOR
FACE FRAME &
FRAMELESS
KITCHEN

LAUNDRY
TO GO.

VS WASH® SPACE XX
VS WASH® SPACE XX PRO
LAUNDRY HAMPER SYSTEMS



Watch it!

FEATURES



Handles make it possible to carry up to two containers at the same time



Gentle on delicate laundry thanks to rounded edges, which also ensure the best possible air circulation



Various bin sizes



Powder-coated lid for extra storage

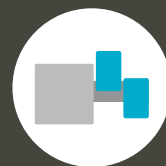





Synchronised runners with over extension

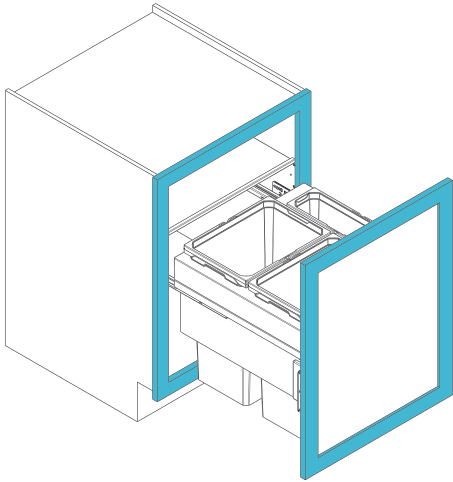

Cam shaft 3-D adjustment

DETAILS



- **Cabinet widths (CAB):** 15", 18", 21" and 24"
- **Cabinet opening (MCO):**
 - FF 12", 15", 18" and 21"
 - FL 13-1/2", 16-1/2", 19-1/2" and 22-1/2"
- **FF width:** 1-1/2"
- **Installation depth:** min. 20-1/2"
- **Installation height:**
 - VS WASH® Space XX: min. 19-1/2"
 - VS WASH® Space XX Pro: min. 23"
- **Capacity:** 31qt to 93qt
- **Finish Fitting:**
 - silver 
 - lava 
 - white/gray 
 - lava/lava 
- **Additionally available:** VS ENVI® Kick

CABINET DIMENSIONS

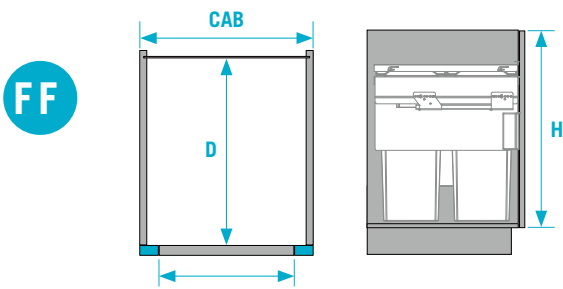

Cabinet widths (CAB)	FF cabinet opening (MCO)	Installation depth (D)	Installation height (H) VS WASH® Space XX	Installation height (H) VS WASH® Space XX Pro
15"	12"	20-1/2"	19-1/2"	23"
18"	15"	20-1/2"	19-1/2"	23"
21"	18"	20-1/2"	19-1/2"	23"
24"	21"	20-1/2"	19-1/2"	23"

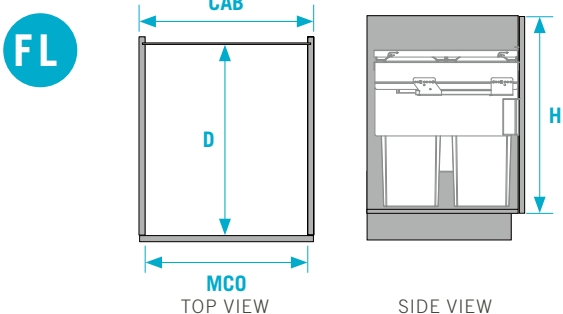

Cabinet widths (CAB)	FL cabinet opening (MCO)	Installation depth (D)	Installation height (H) VS WASH® Space XX	Installation height (H) VS WASH® Space XX Pro
15"	13-1/2"	20-1/2"	19-1/2"	23"
18"	16-1/2"	20-1/2"	19-1/2"	23"
21"	19-1/2"	20-1/2"	19-1/2"	23"
24"	22-1/2"	20-1/2"	19-1/2"	23"

UNDER DRAWER

- Under cabinet / drawer wash bin
- Top mounted
- Pullouts with soft-close

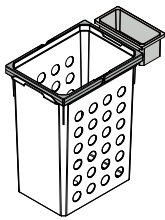
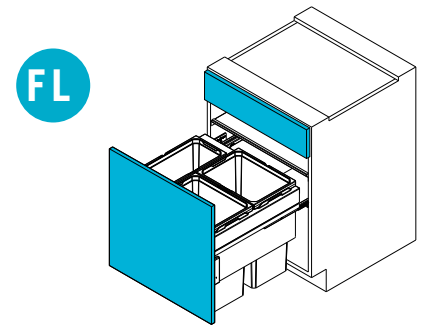
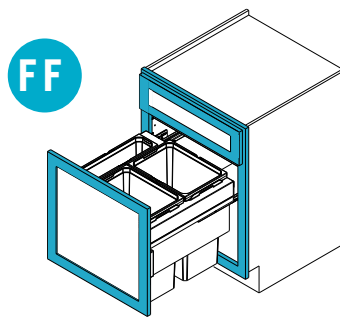

Cabinet width 15"
1 bin 31qt + 1 box 1.5qt

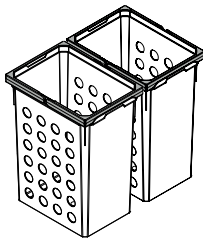

Cabinet width 18"
2 bins 31qt

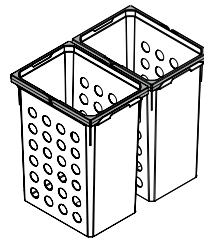

Cabinet width 21"
2 bins 31qt

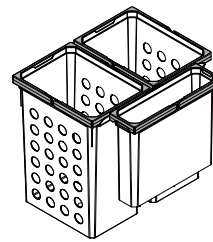

Cabinet width 24"
2 bins 31qt + 1 bin 10qt

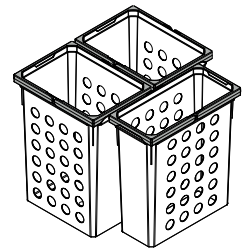

Cabinet width 24"
2 bins 31qt + 1 bin 22qt

Fitting color
silver

Bin color
white / gray

		Cabinet width	Cabinet opening	Product height	Product width	Product depth	Capacity
FF	10090010497	15"	12"	19-1/6"	13-1/2"	20-3/8"	1 bin 31qt + 1 box 1.5qt
FL	10090010485	15"	13-1/2"	19-1/6"	13-1/2"	20-3/8"	1 bin 31qt + 1 box 1.5qt
FF	10090010500	18"	15"	19-1/6"	16-1/2"	20-3/8"	2 bins 31qt
FL	10090010488	18"	16-1/2"	19-1/6"	16-1/2"	20-3/8"	2 bins 31qt
FF	10090010503	21"	18"	19-1/6"	19-1/2"	20-3/8"	2 bins 31qt
FL	10090010491	21"	19-1/2"	19-1/6"	19-1/2"	20-3/8"	2 bins 31qt
FF	10090010478	24"	21"	19-1/6"	22-1/2"	20-3/8"	2 bins 31qt + 1 bin 10qt
FL	10090010494	24"	22-1/2"	19-1/6"	22-1/2"	20-3/8"	2 bins 31qt + 1 bin 22qt

FULL HEIGHT

- Full height wash bin
- Top mounted
- Pullouts with soft-close

FF

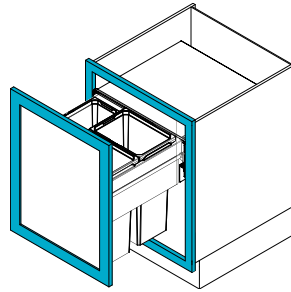

FL

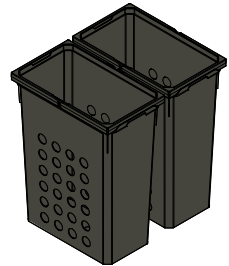
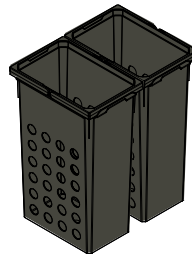
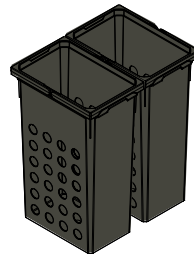
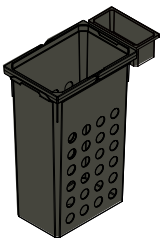
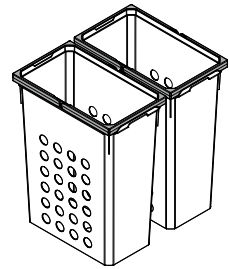
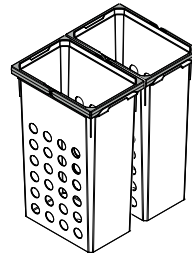
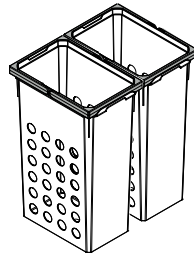
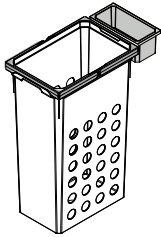
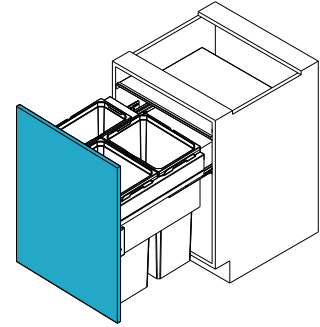

Cabinet width 15"
1 bin 35qt + 1 box 1.5qt

Cabinet width 18"
2 bins 37qt

Cabinet width 21"
2 bins 37qt

Cabinet width 24"
2 bins 46.5qt

Fitting color silver

Fitting color lava

Bin color white / gray

Bin color lava / lava

			Cabinet width	Cabinet opening	Product height	Product width	Product depth	Capacity
FF	10090010496	10090010495	15"	12"	22-5/8"	13-1/2"	20-3/8"	1 bin 35qt + 1 box 1.5qt
FL	10090010484	10090010483	15"	13-1/2"	22-7/16"	13-1/2"	20-3/8"	1 bin 35qt + 1 box 1.5qt
FF	10090010499	10090010498	18"	15"	22-5/8"	16-1/2"	20-3/8"	2 bins 37qt
FL	10090010487	10090010486	18"	16-1/2"	22-7/16"	16-1/2"	20-3/8"	2 bins 37qt
FF	10090010502	10090010501	21"	18"	22-5/8"	19-1/2"	20-3/8"	2 bins 37qt
FL	10090010490	10090010489	21"	19-1/2"	22-7/16"	19-1/2"	20-3/8"	2 bins 37qt
FF	10090010477	10090010504	24"	21"	22-5/8"	22-1/2"	20-3/8"	2 bins 46.5qt
FL	10090010493	10090010492	24"	22-1/2"	22-7/16"	22-1/2"	20-3/8"	2 bins 46.5qt

Vauth-Sagel USA LP
1821 Baker Road
High Point, NC 27263
USA

Phone +1 (336) 861 0740

Toll free +1 855 770 9121

Fax +1 336 861 0741

Email vsusasales@vauth-sagel.com

Internet www.vauth-sagel.de/us/en



Imprint

All parts of this brochure are the property of Vauth-Sagel. Reproduction of the brochure or parts thereof in any form is prohibited without our approval. We reserve all rights under copyright law. Any liability for typographical mistakes or errors is excluded. The dimensions are non-binding. We reserve the right to make design and technical changes.

Publisher

Vauth-Sagel | Neue Straße 27 | 33034 Brakel-Erkeln | Telephone: +49 (0) 5272 601-01
Email: vs@vauth-sagel.com | www.vauth-sagel.com

Version: April 2024 | © by Vauth-Sagel | All Rights Reserved.



VAUTH-SAGEL USA LP

1821 Baker Road | High Point, NC 27263

+1 (336) 861 0740

vsusasales@vauth-sagel.com

www.vauth-sagel.com

Follow us on

